



# NATURAL SERIES

bathco

NATURAL SERIES

**SOLID SURFACE**  
P. 12

**STONE**  
P. 84

**CEMENT & TERRAZZO**  
P. 164

**WOOD**  
P. 212

**MICROCEMENT**  
P. 232

**\*PRODUCT INDEX - P. 244**

# NATURAL SERIES: LA PUREZA DE LOS MATERIALES

## NATURAL SERIES: THE PURITY OF THE MATERIALS

Hubo un artista en el Renacimiento italiano que, tras esculpir una obra magnífica y presentarla en sociedad, recibió elogios de su mecenas y colegas de profesión. Él respondió a estos otorgándole el mérito a la propia naturaleza y al bloque de mármol en el que había cincelado su obra. Decía que la escultura siempre había estado ahí, en una cantera, encerrada en el bloque de mineral y que él sólo se había limitado a quitar las esquirlas de piedra que impedían apreciarla. El mérito, continuó, no estaba en sus manos, sino en la propia materia prima. En su pureza. En su nobleza.

Natural Series fue concebida bajo la misma premisa: otorgar todo el protagonismo a los materiales, reivindicar la grandeza y las geometrías más puras de estos. Son los materiales los que transmiten el mensaje de la firma en esta nueva entrega de la colección: líneas sencillas, intervenciones mínimas y perfiles limpios que se basan directamente en las formas primigenias de la naturaleza y en la vertiente más geológica de ésta. Con ello, Natural Series renueva su compromiso con la elegancia, distinción y exclusividad sirviéndose de un minimalismo orgánico.

There was an artist in the Italian Renaissance who, after sculpting a magnificent work and presenting it to society, received accolades from his patron and fellow-artists. He responded to them by attributing the merit to nature itself and to the block of marble he had chiselled to create his work. He said that the form had always been there, even in the quarry, locked in the block of rock, and that he had merely chipped off the shards that had kept it hidden from view. The merit, he continued, was not in his hands, but in the raw material itself. In its purity. In its nobility.

Natural Series was conceived under the same premise: making the materials the protagonist, honouring their greatness and purest geometries. The materials are what transmit the firm's message in this new version of the collection: simple lines, minimal intervention and clean contours based directly on the raw original forms of nature at its most geological. With it, Natural Series renews its commitment to elegance, distinction and exclusivity by making use of organic minimalism.



*The philosophy of this collection lies in making the materials the protagonist, honouring their greatness and purest geometries.*

*La filosofía de esta colección consiste en otorgar protagonismo a los materiales, reivindicar la grandeza y las geometrías más puras de estos.*

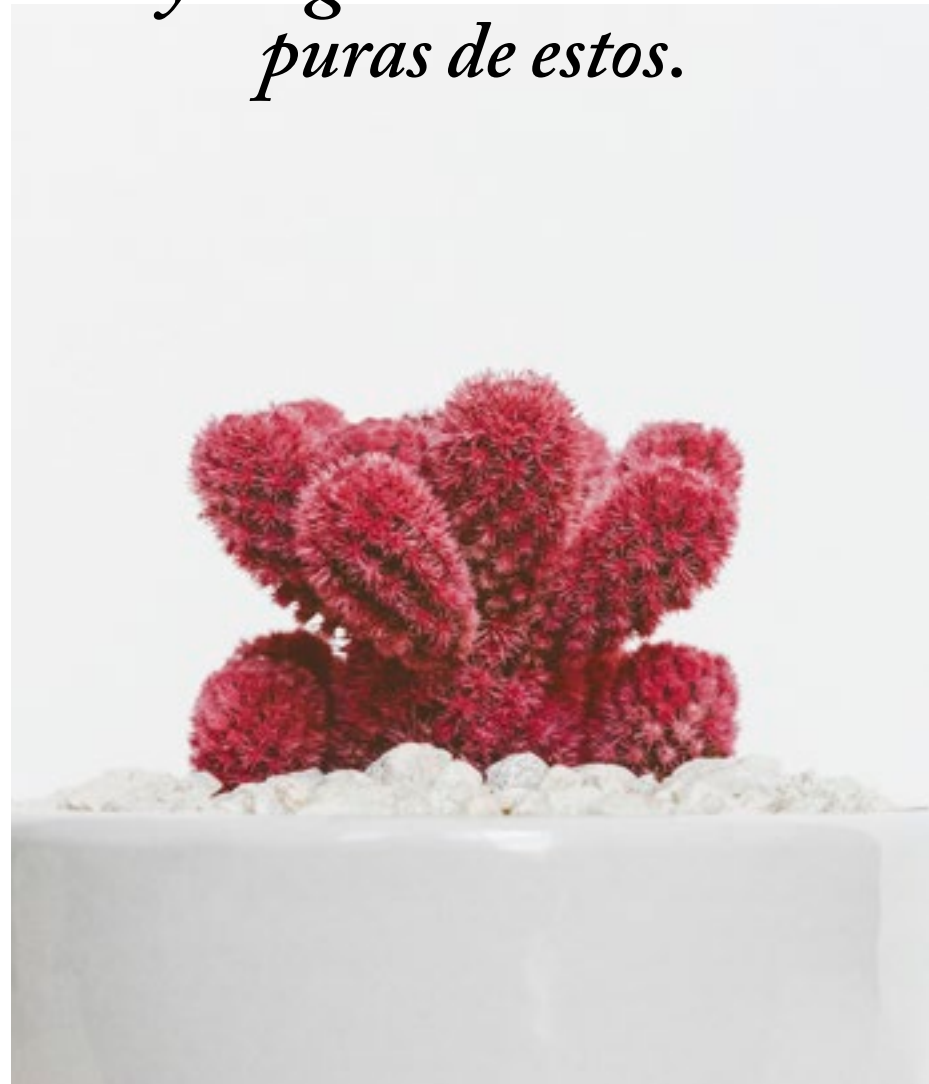

Bathco, a través de Natural Series, apuesta por una gama de texturas que dinamizan baños y aseos para que estos también puedan asumir las innovaciones estéticas que se producen en otros rincones del hogar. La colección realiza un viaje completo en torno a la pureza de los materiales partiendo, por supuesto, de la piedra a través de la serie Stone y las tonalidades calizas y pizarras de Cement & Terrazzo. Reivindica, también, patrones más innovadores gracias a Solid Surface para adentrarse en el territorio de la piedra artificial y la naturaleza sintética. Esto último se pone de manifiesto en los acabados de Microcement que reivindican una materia prima que nunca pasa de moda y se reinventa en nuevos formatos y en nuevos usos. La madera también está presente gracias a Wood, un ejercicio de elegancia que contribuye a dotar de calidez una estancia tradicionalmente asociada al alicatado y la piedra.

En Natural Series se incorporan las señas de identidad de Bathco, haciendo especial hincapié en el equilibrio entre el diseño y la funcionalidad, siendo esta última una característica esencial en los cuartos húmedos de un hogar.

Bathco, in Natural Series, sets its sights on a range of textures that enliven bathrooms and restrooms so that they too can absorb the aesthetic innovations taking place in other parts of the home. The collection makes a complete journey through the purity of the materials, starting, of course, with stone with the Stone series and the limestone and slate shades of Cement & Terrazzo. It also honours more innovative patterns thanks to Solid Surface, to explore the territory of artificial stone and synthetic nature. The latter is on display in the Microcement finishes that celebrate a raw material that never goes out of style and is being reinvented in new formats and new uses. Wood is also present thanks to Wood, an exercise in elegance that helps give warmth to room traditionally associated with tile and stone.

In Natural Series, Bathco's hallmarks are present, with special emphasis on the balance between design and functionality, with the latter being an essential feature of wet areas in a home.

**ELEGANCIA,  
DISTINCIÓN Y  
EXCLUSIVIDAD**

**ELEGANCE,  
DISTINCTION  
AND EXCLUSIVITY**

# PASCUAL SALVADOR



“ *Creo que existe una calidad cultural de los materiales y hay que intentar aprovechar sus posibilidades.*

*I think these materials have a cultural quality and that we have to take advantage of their possibilities.* ”

El prestigioso arquitecto de interiores y diseñador industrial Pascual Salvador es el responsable de las novedades de Natural Series. Su trayectoria profesional se inició hace más de cuatro décadas y lleva años colaborando con la firma, dejando su huella y talento también en varias creaciones del catálogo general.

En este catálogo sigue siendo un diseñador puro, un defensor de la intuición comprometido con proyectos que recorran senderos no trillados. Funcionalidad, innovación y estética son sus únicos credos.

The prestigious interior architect and industrial designer Pascual Salvador is the person responsible for the new products in the Natural Series range. His career began over four decades ago, and he's been collaborating with the firm for years, leaving his mark on and applying his talent to various creations in the general catalogue. In this catalogue he continues to be a pure designer, a believer in intuition who is committed to projects that veer off the beaten track. Functionality, innovation and aesthetics are his only credos.

*Sin materiales nobles no se puede desarrollar un buen ejercicio de diseño y funcionalidad.*

*Without noble materials it is impossible to develop a successful exercise of design and functionality.*

En Natural Series, Pascual Salvador tenía muy claro el objetivo de la línea: lograr que la atención se centrara en los materiales y, una vez conseguido, poner en valor las cualidades naturales de estos, que las piezas pudieran convertirse en los epicentros estéticos de las estancias. Partiendo de esa premisa, luego comenzaron los trabajos en pos de una funcionalidad, una innovación, una estética y, sobre todo, una complicidad emocional que fuera fiel a los valores de Bathco.

El proceso es similar al ocurrido en la alta gastronomía donde toda innovación, todo hallazgo carece de sentido si no se respeta la esencia misma del producto. Sin una buena materia prima no puede haber una buena cocina. En diseño, sin materiales nobles no se puede desarrollar un buen ejercicio de diseño y funcionalidad. A la hora de crear las piezas para Natural Series, Pascual Salvador profundizó en su propia fascinación por la ligereza visual de la piedra y la capacidad que tiene ésta para transmitir tanto desde una aparente simplicidad.

Pascual Salvador siempre ha defendido la importancia máxima del usuario a la hora de enfrentarse a un nuevo trabajo, saber que todos los esfuerzos impresos en una pieza van a redundar en las personas que la utilicen y que éstas se van a beneficiar de su funcionalidad y su estética. Natural Series es el espejo en el que se reflejan todas estas pulsiones, piezas que reivindican la grandeza de los materiales y, a la vez, llenan de plasticidad los espacios en los que se instalan.

In Natural Series, Pascual Salvador understood the objective of the line very clearly: to focus attention on the materials and, then, honour the natural qualities of these, to make the pieces the aesthetic epicentre of the rooms. Starting with this premise, work began in the search for functionality, innovation, an aesthetic and, above all, an emotional complicity in line with Bathco's values.

The process is similar to the one used in elite gastronomy, where every innovation, every discovery is meaningless if the essence of the product itself is not respected. Without quality raw materials, fine cuisine is impossible. In design, without noble materials it is impossible to develop a good exercise of design and functionality. When it comes to creating the pieces for Natural Series, Pascual Salvador explored his own fascination with the visual lightness of stone and its capacity to transmit great meaning with apparent simplicity.

Pascual Salvador has always defended the maximum importance of the user when starting a new job, knowing that all the efforts applied to a piece will affect the people who use it, and that they will benefit from its functionality and aesthetics. Natural Series is a mirror that reflects all of these impulses, pieces that honour the greatness of the materials and, at the same time, fill the spaces where they are installed with plasticity.

*Conseguir  
unos perfiles  
determinados  
por su ligereza  
visual sin  
renunciar a sus  
características*

*Achieving  
certain contours  
determined by  
their visual  
lightness without  
renouncing their  
characteristics*

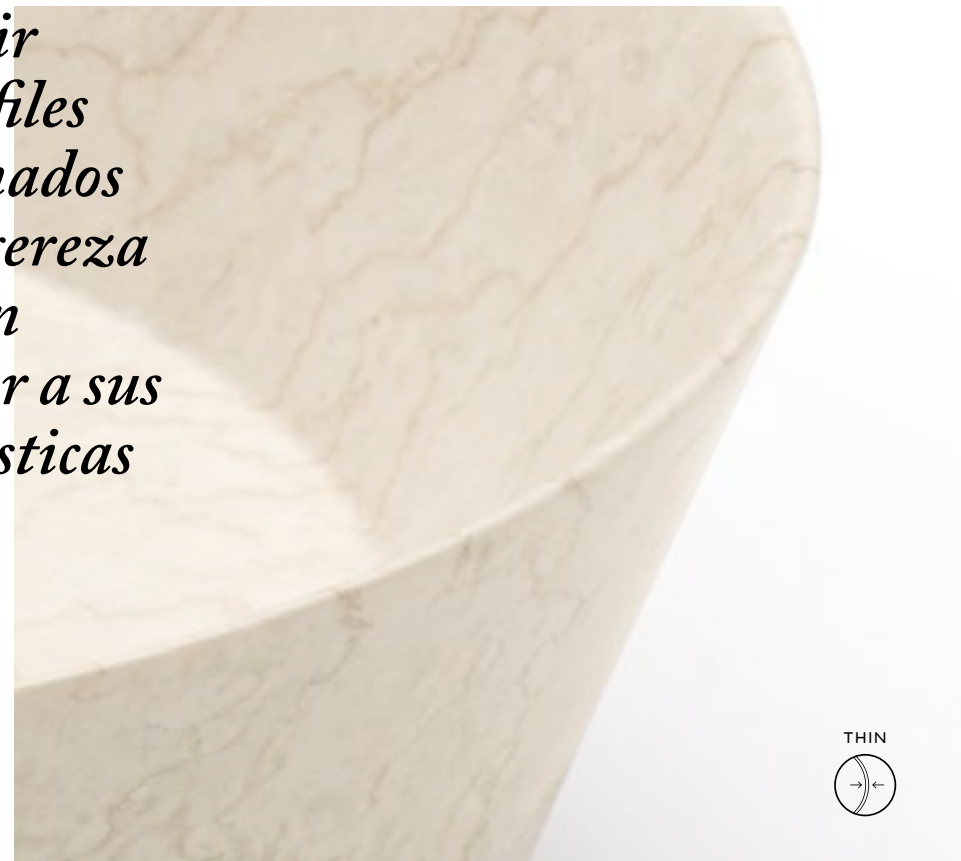

Una pieza bien diseñada es aquella que insinúa, que deja una huella sutil, que está presente en una estancia pero no la condena. La característica Thin de Bathco va un paso más allá en la filosofía de la firma creando unos acabados visuales más ligeros sin renunciar a la esencia ni a sus características. Los lavabos Thin cuentan con unas aristas más depuradas, con una fisionomía más esbelta, más propia de una delicada vajilla que de una línea de baño. Thin es ligereza visual que se traduce en un menor peso y, en general, un baño más estilizado. Thin es un concepto que recorre algunas de las piezas de las diferentes colecciones de Bathco, creando un producto limitado y único.

A well-designed piece is one that insinuates, that makes a subtle mark, that is present in a room but does not determine it. Bathco's distinctive Thin takes the firm's philosophy one step further by creating lighter visual finishes while renouncing neither their essence nor their characteristics. The Thin washbasins have very refined edges, with a slimmer look, more typical of fine china than of a bathroom line. Thin is visual lightness that is translated into less weight and, in general, a sleeker bathroom. Thin is a concept that touches on some of the pieces of the different Bathco collections, creating an exclusive and unique product.



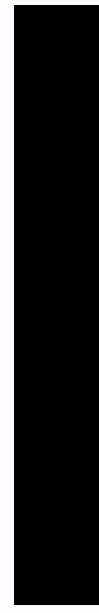

## SOLID SURFACE

---

Líneas puras, luminosidad y geometrías simples. Solid Surface conecta con el lavabo tradicional y, a la vez, lo proyecta hacia el futuro amplificando sus posibilidades estéticas y su versatilidad. Recurre al color blanco, el mismo que siempre ha estado presente en nuestros baños, para crear nuevas formas, homenajes a las ya existentes y evoluciones necesarias.

Pure lines, luminosity and simple geometries. Solid Surface connects with the traditional washbasin and, at the same time, projects it towards the future, amplifying its aesthetic possibilities and its versatility. It relies on white, the colour that has always been present in our bathrooms, to create new forms and pay homage to familiar ones and their necessary evolutions.



SOLID SURFACE

## PRODUCT INDEX

LAVABOS / WASHBASINS

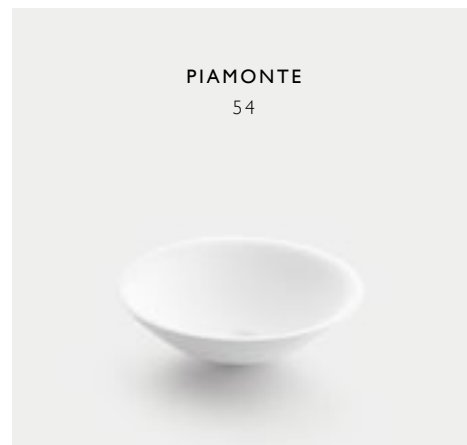
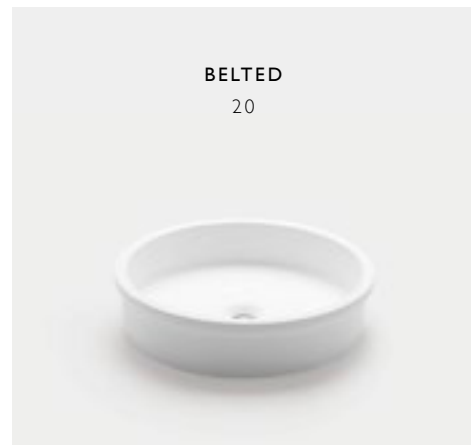

SOLID SURFACE

LAVABOS / WASHBASINS

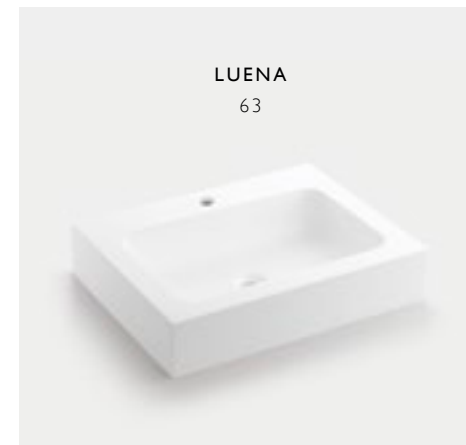



---

LAVABOS / WASHBASINS

---



---

MUEBLES / FURNITURE COMPLEMENTS

---

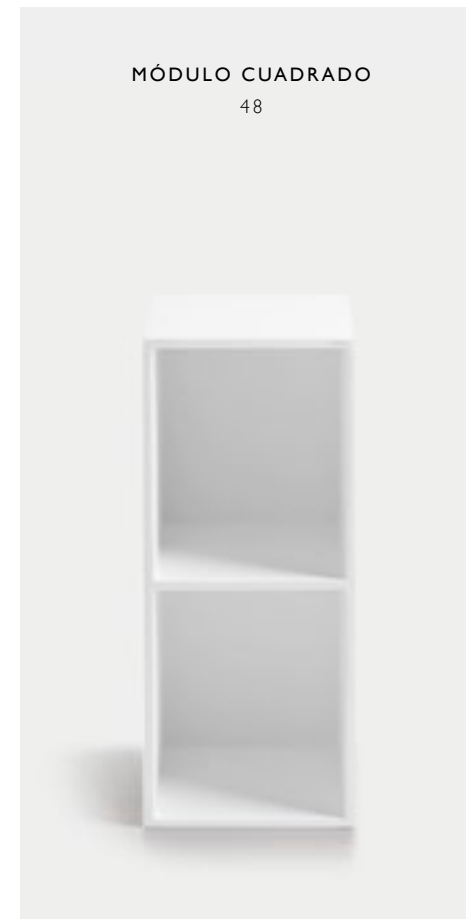

---

MUEBLES / FURNITURE COMPLEMENTS

---

PADUA  
28



LIVORNO  
30



SORRENTO  
32



TARENTO  
36



---

MUEBLES LAVABO / FURNITURE SETS

---

BELTED  
40



SOLID SURFACE

## BELTED

LA DIVINIDAD, A MENUDO, SE MANIFIESTA EN LOS PEQUEÑOS DETALLES. BELTED REIVINDICA LA PERFECCIÓN GEOMÉTRICA Y, TAMBIÉN, LA FUERZA DE UN PERÍMETRO POCO USUAL.

DIVINITY IS OFTEN MANIFESTED IN THE SMALLEST DETAILS BELTED HONOURS GEOMETRIC PERFECTION, AND ALSO THE STRENGTH, OF AN UNUSUAL PERIMETER.



REF 6015  
0279\_85

Lavabo de semiencastre / Semi-recessed washbasin  
Ø 420 x H 100



SOLID SURFACE

# TRIESTE

TRIESTE PUDO SER UNA PIEZA DE VAJILLA. CON SU ARMONÍA, CON SUS CURVAS ORGÁNICAS, CON UNAS PAREDES ESBELTAS Y DELICADAS QUE ACARICIAN EL AGUA.  
TRIESTE COULD BE A PIECE OF FINE CHINA. WITH ITS HARMONY, WITH ITS ORGANIC CURVES, WITH SLENDER, DELICATE WALLS THAT CARESS THE WATER.



REF 6017  
0299\_85

Lavabo sobre encimera / Topcounter washbasin  
W 450 x P 300 x H 120





SOLID SURFACE

# UMBRÍA

LA DELICADEZA SE MANIFIESTA EN SUS FORMAS Y EN LAS FUNCIONALIDADES QUE  
ESCONDEN ÉSTAS. UMBRÍA SE CURVA PARA ACERCARSE AL USUARIO, SE ADAPTA A ÉL.  
DELICATENESS IS MANIFESTED IN ITS FORMS AND IN THE FUNCTIONALITY THEY  
CONCEAL. UMBRÍA CURVES TO APPROACH THE USER, TO ADAPT TO THE PERSON.



REF 6016  
0268\_95

Lavabo sobre encimera / Topcounter washbasin  
Ø 380 x H 120



SOLID SURFACE

## PADUA

ES POSIBLE AUNAR DISEÑO Y EFICACIA EN UNA PIEZA DE FORMAS SUTILES Y  
DETALLES EXQUISITOS COMO LOS TOALLEROS INTEGRADOS.  
IT'S POSSIBLE TO PURSUE DESIGN AND PRACTICALITY IN A PIECE WITH SUBTLE  
FORMS AND EXQUISITE DETAILS LIKE INTEGRATED TOWEL RAILS.



REF 6027  
01575\_00

Mueble lavabo / Washbasin cabinet  
W 1000 x P 420 x H 835



SOLID SURFACE

# LIVORNO

FIEL A LAS LÍNEAS PURAS PERO ATREVIDO EN LOS JUEGOS GEOMÉTRICOS, LIVORNO,  
CONVIERTE LA HIGIENE EN UN RITUAL SALPICADO DE MODERNIDAD.  
FAITHFUL TO PURE LINES BUT BOLD IN ITS PLAY OF GEOMETRY, LIVORNO MAKES  
CLEANSING A RITUAL SPLASHED WITH MODERNITY.



REF 6028  
01795\_00

Mueble lavabo / Washbasin cabinet  
W 1000 x P 450 x H 855





SOLID SURFACE

## SORRENTO

LAVABO CON MENORES DEMANDAS ESPACIALES, CONTEMPORÁNEO Y DE GUIÑOS GEOMÉTRICOS, SORRENTO BRILLA EN LAS ESTANCIAS SIN NECESIDAD DE ARTIFICIOS. DISPONIBLE EN DOS TAMAÑOS.

WASHBASIN WITH A SMALLER FOOTPRINT, CONTEMPORARY AND WITH ALLUSIONS TO GEOMETRY, SORRENTO SHINES IN ROOMS WITHOUT THE NEED FOR ARTIFICE. AVAILABLE IN TWO SIZES.



REF 6029

01195\_00

Mueble lavabo / Washbasin cabinet  
W 700 x P 440 x H 855



REF 6030  
01489\_00

Mueble lavabo / Washbasin cabinet  
W 1000 x P 440 x H 855



SOLID SURFACE

# TARENTO

TARENTO TIENE VOCACIÓN FUNCIONAL, REPARTIENDO SABIAMENTE LAS SUPERFICIES PARA DIFERENTES USOS Y DANDO A LA PILA LA IMPORTANCIA JUSTA.  
TARENTO IS COMMITTED TO FUNCTIONALISM, WISELY DISTRIBUTING THE SURFACES FOR DIFFERENT USES AND GIVING THE SINK ITS RIGHTFUL PLACE.



REF 6031  
01495\_00

Mueble lavabo / Washbasin cabinet  
W 700 x P 500 x H 859





REF 6032  
01895\_00

Mueble lavabo / Washbasin cabinet  
W 1000 x P 500 x H 859

SOLID SURFACE

## BELTED

ELEGANTE PIEZA GLOBAL EN LA QUE TANTO PILA COMO MUEBLE JUEGAN CON LAS FORMAS CIRCULARES Y REORGANIZAN SABIAMENTE LAS SUPERFICIES.  
DISPONIBLE EN PAREJA.

ELEGANT SET IN WHICH BOTH THE WASHBASIN AND THE CABINET PLAY WITH CIRCULAR FORMS AND WISELY REORGANISE THE SURFACES. ALSO AVAILABLE IN A DOUBLE-SINK VERSION.

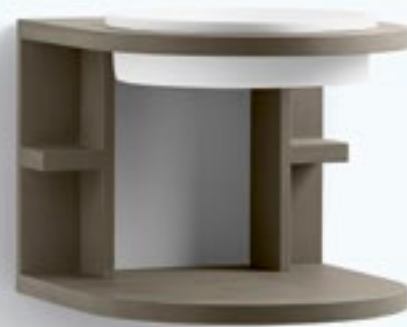

REF 6023GR Gris / REF 6023RB Roble  
01795\_85

Mueble lavabo / Washbasin cabinet  
W 520 x P 550 x H 430



REF 6024RB Roble / REF 6024GR Gris  
02895\_00

Mueble lavabo / Washbasin cabinet  
W 1040 x P 550 x H 430



SOLID SURFACE

## BARI

LA SUTILEZA VISUAL REPRESENTADA EN UN LAVABO DE DOBLE POZA. BARI, CON SU CURVATURA LIMPIA GENERA UN AMBIENTE BIEN EQUIPADO A LA PAR QUE ARMÓNICO.  
VISUAL SUBTLETY REPRESENTED IN A DOUBLE-SINK WASHBASIN. BARI, WITH ITS CLEAN CURVATURE, GENERATES AN ATMOSPHERE THAT IS AS WELL EQUIPPED AS IT IS HARMONIOUS.



REF 6022  
01295\_00

Lavabo suspendido doble poza / Wall-hung double washbasin  
W 1200 x P 400 x H 140







SOLID SURFACE

# CUADRADO

QUINTAESENCIA DEL MINIMALISMO. SIN CURVAS, RINDIENDO HOMENAJE AL  
ÁNGULO RECTO. CUADRADO ES VANGUARDIA, FUTURO Y ELEGANCIA VISUAL.  
QUINTESENCE OF MINIMALISM. WITHOUT CURVES, PAYING TRIBUTE TO THE  
RIGHT-ANGLE, CUADRADO IS AVANT GARDE, FUTURISTIC AND VISUALLY ELEGANT.



REF 6025  
01795\_85

Lavabo pedestal / Pedestal washbasin  
W 360 x P 360 x H 850



REF 6026  
01989\_85

Módulo cuadrado / Square storage unit  
W 360 x P 360 x H 850





SOLID SURFACE

# POLARIS

AQUELLO QUE REPRESENTA EL BLANCO A LA PALETA DE COLORES ES LO QUE SIGNIFICA POLARIS PARA NATURAL SERIES: ESTILO Y DISEÑO SIN RODEOS.  
WHAT WHITE REPRESENTS IN THE COLOUR PALETTE IS WHAT POLARIS REPRESENTS IN THE BATHCO NATURAL SERIES: STYLE AND NO-NONSENSE DESIGN.



REF 6001  
0136\_00

Lavabo sobre encimera / Topcounter washbasin  
Ø 300 x H 100



SOLID SURFACE

## PIAMONTE

LA PILA TRADICIONAL SOMETIDA A UN TRATAMIENTO DE ESTILIZACIÓN DE SUS FORMAS. TACTOS FAMILIARES, PERFILES DELICADOS Y UNA SINTONÍA TOTAL CON ENTORNOS ZEN.

THE TRADITIONAL FONT REINTERPRETED TO STYLIZE ITS FORM. FAMILIAR TEXTURES, DELICATE CONTOURS AND COMPLETELY IN TUNE WITH ZEN ATMOSPHERES.



REF 6002  
0268\_00

Lavabo sobre encimera / Topcounter washbasin  
Ø 420 x H 120



SOLID SURFACE

# SAJA

SÓLO CUANDO SE TRABAJA LA EVOLUCIÓN DE LAS FORMAS Y SE HACE UN EJERCICIO DE FUNCIONALIDAD SURGE UNA PIEZA COMO SAJA. LO MÁXIMO A PARTIR DE LO MÍNIMO.  
ONLY WHEN THE EVOLUTION OF THE FORMS IS ADDRESSED AND THERE IS AN EXERCISE OF FUNCTIONALISM CAN A PIECE LIKE SAJA EMERGE. THE MAXIMUM FROM THE MINIMUM.



REF 6003  
0339\_00

Lavabo con toallero / Washbasin with towel rail  
W 660 x Ø 420 x H 120





SOLID SURFACE

# LUENA

SI HUBIERA QUE APLICAR EL CONCEPTO DEL 'LAVABO DE TODA LA VIDA' A UNA PIEZA, LUENA SERÍA LA DESTINATARIA. CURVAS Y RECTAS EN UNA REVISIÓN NECESARIA.  
IF WE HAD TO APPLY THE CONCEPT OF 'WASHBASIN WE'VE SEEN ALL OUR LIVES' TO A PIECE, LUENA WOULD BE THE WINNER. CURVES AND STRAIGHT LINES IN A NECESSARY REVISION.



REF 6007  
0939\_00

Lavabo sobre encimera / Topcounter washbasin  
W 1000 x P 450 x H 120

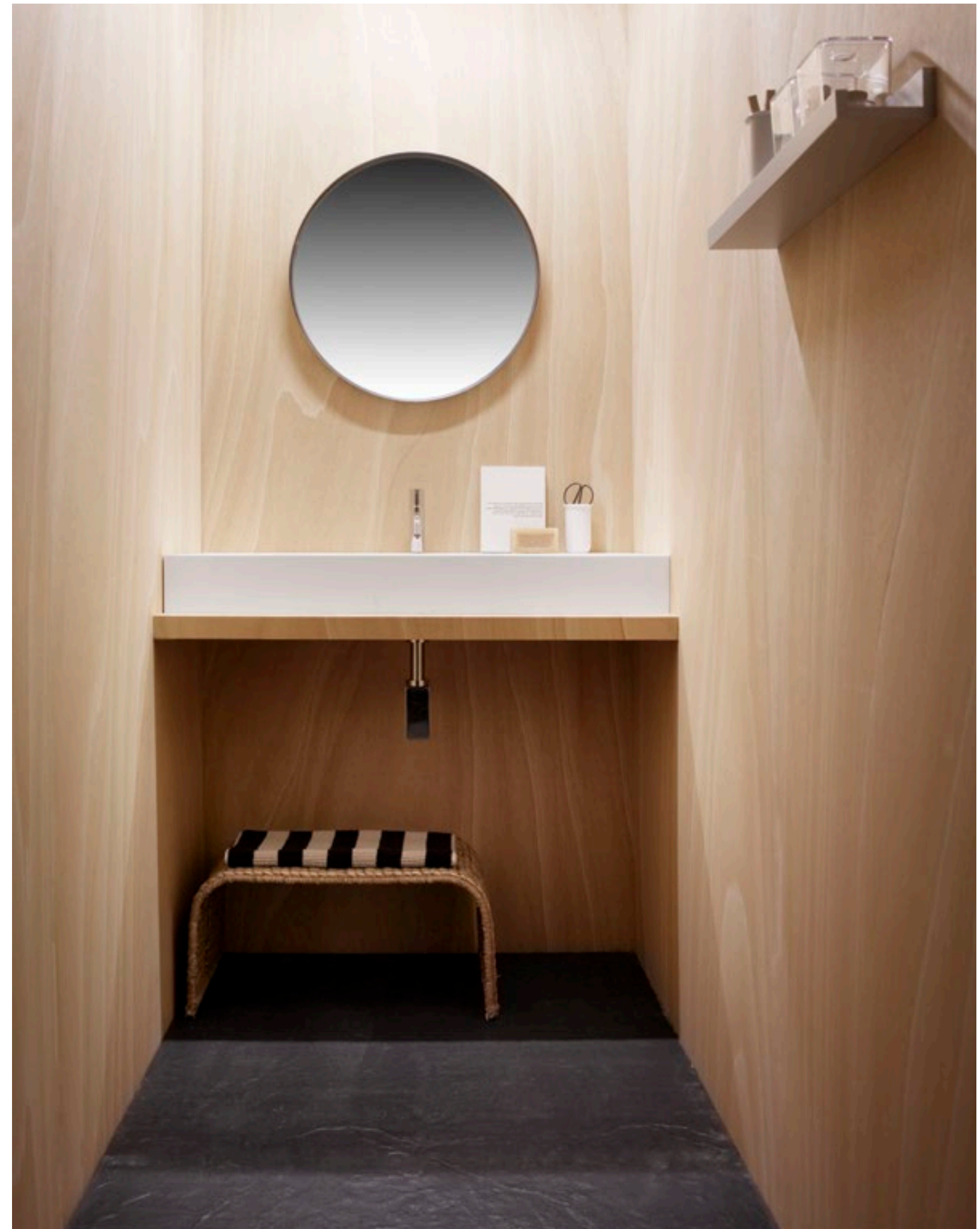



REF **6005**  
0509\_00  
Lavabo sobre encimera / Topcounter washbasin  
W 450 x P 450 x H 120



REF **6006**  
0618\_00  
Lavabo sobre encimera / Topcounter washbasin  
W 600 x P 450 x H 120



SOLID SURFACE

# CALABRIA

CONJUNTO DE PILA Y ENCIMERA EN EL QUE MATERIALES Y FORMAS SE SOLAPAN ARTÍSTICAMENTE. CALABRIA ES PURO DISEÑO AL SERVICIO DE LA FUNCIÓN.  
A WASHBASIN AND TOP WHERE THE MATERIALS AND FORMS OVERLAP ARTISTICALLY. CALABRIA IS PURE DESIGN AT THE SERVICE OF FUNCTION.



REF 6011A  
0998\_00

Lavabo suspendido con balda derecha.  
Incluye baldas en roble blanco y wengué. /  
Wall-mounted washbasin with right top.  
White oak and wengue tops included.  
W 760 x P 450 x H 300



REF 6011B  
0998\_00

Lavabo suspendido con balda izquierda  
Incluye baldas en roble blanco y wengué. /  
Wall-mounted washbasin with left top  
White oak and wengue tops included.  
W 760 x P 450 x H 300





REF 6012

01967\_00

Lavabo doble cuadrado con balda.  
Incluye baldas en roble blanco y wengué. / Double washbasin with top.  
White oak and wengue tops included.  
W 1520 x P 450 x H 300

SOLID SURFACE

# NANSA

PILA ATEMPORAL, ESTÉTICA LIGERA Y GRAN TAMAÑO QUE PONE EN VALOR EL PAPEL DEL AGUA EN LAS ESTANCIAS HÚMEDAS DE LA CASA.  
TIMELESS WASHBASIN, LIGHT AESTHETICS AND A LARGE SIZE THAT HIGHLIGHTS THE ROLE OF WATER IN THE WET AREAS OF THE HOME.



REF 6008  
0476\_00

Lavabo semi encastrable / Semi-recessed washbasin  
W 600 x P 500 x H 120



REF 6008 / 0301  
01095\_00

Lavabo semi encastre sobre encimera de  
acero inox con accesorios /  
Semi-recessed washbasin combined with  
stainless steel frame with accessories  
W 700 x P 500 x H 180



REF 6009  
0559\_00

Lavabo semi encastre /  
Semi-recessed washbasin  
W 800 x P 500 x H 120

REF 6009 / 0302  
01248\_00

Lavabo semi encastre sobre encimera  
de acero inox con accesorios /  
Semi-recessed washbasin combined with stainless  
steel frame with accessories  
W 900 x P 500 x H 180

SOLID SURFACE

## MONTY

LA MÁS SINUOSA DE LAS PIEZAS DE NATURAL SERIES DE BATHCO. DISEÑO ATREVIDO AL SERVICIO DE UNA FUNCIONALIDAD ÓPTIMA QUE COMBINA PLANOS ANTAGÓNICOS.  
THE MOST SINUOUS PIECE IN THE BATHCO NATURAL SERIES. BOLD DESIGN AT THE SERVICE OF OPTIMAL FUNCTIONALITY COMBINING ANTAGONISTIC PLANES.



REF 6004  
0796\_00

Lavabo suspendido / Wall-mounted washbasin  
W 800 x P 425 x H 300





SOLID SURFACE

## VENETO

UNA INTERSECCIÓN DE PLANOS Y DIFERENTES ÁNGULOS PARA CONSEGUIR UNA PIEZA SOBRIA Y DE MUY REDUCIDO TAMAÑO. VENETO SE ADAPTA A CUALQUIER ZONA HÚMEDA DEL HOGAR. DISPONIBLE EN DOS VERSIONES.  
AN INTERSECTION OF PLANES AND CONTRASTING ANGLES TO ACHIEVE A SOBER PIECE WITH A VERY SMALL FOOTPRINT. VENETO ADAPTS TO ANY WET AREA OF THE HOME. AVAILABLE IN TWO VERSIONS.



REF 6014  
0967\_00

Lavabo suspendido / Wall-mounted washbasin  
W 450 x P 420 x H 320





REF 6010

01639\_00

Lavabo pedestal | Pedestal washbasin  
W 450 x P 420 x H 870





SOLID SURFACE

# BARROS

EL DISEÑO MÁS VIVO Y UTILITARIO DE BATHCO, UNA PIEZA QUE EMERGE DE LA TIERRA PARA EL RITUAL DE LA HIGIENE DIARIA.  
BATHCO'S MOST VIVID AND UTILITARIAN DESIGN, A PIECE THAT EMERGES FROM THE EARTH FOR THE DAILY CLEANSING RITUAL.



REF 6013  
01785\_00

Lavabo pedestal / Pedestal washbasin  
W 390 x P 420 x H 880



# 2

## STONE

---

La consideración de ciertas piedras como rocas nobles tiene más de 5.000 años. Las piezas Stone son un paso más en esa tradición milenaria. Basculan entre el gris y el beige, entre el mármol y el granito, entre los acabados pulidos a bujarda y los estriados, siempre con la intención de añadir distinción a un espacio de uso cotidiano.

The consideration of certain minerals as noble stones goes back 5,000 years. The Stone pieces are another step in this thousand-year tradition. They oscillate between grey and beige, between marble and granite, between bush-hammered and striated finishes, always with the intention of adding distinction to a space designed for daily use.



STONE

## PRODUCT INDEX

LAVABOS / WASHBASINS

SEYCHELLES  
100



ZANZIBAR  
112



MADAGASCAR  
92



COMOROS  
108



MAURITIUS  
96



REUNION  
104



STONE

LAVABOS / WASHBASINS

VULKA  
142



FIJI  
162



LUNGO SQUARE  
158



MONTENEGRO  
154



MIRAGE  
140



STONE

LAVABOS / WASHBASINS

VERSALLES  
134



ICONO  
130



COPLATO  
150



DUOTONO A  
144



DUOTONO B  
148



AROS  
156



STONE

MUEBLES LAVABO / FURNITURE SETS

SIMI  
116



OCO  
122



VERONA  
126



CALABRIA  
138



STONE

---

MUEBLES / FURNITURE COMPLEMENTS

---

PEDESTAL  
130

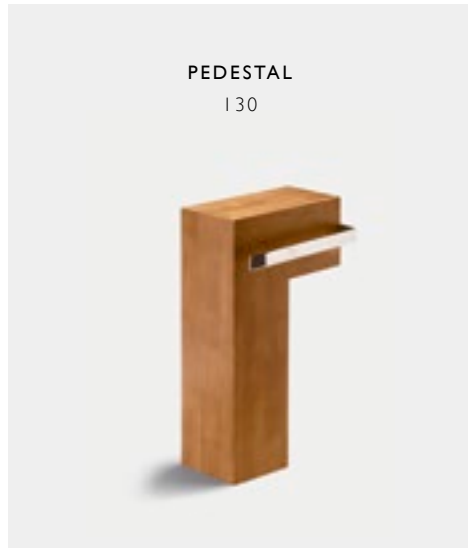

VERSALLES  
134

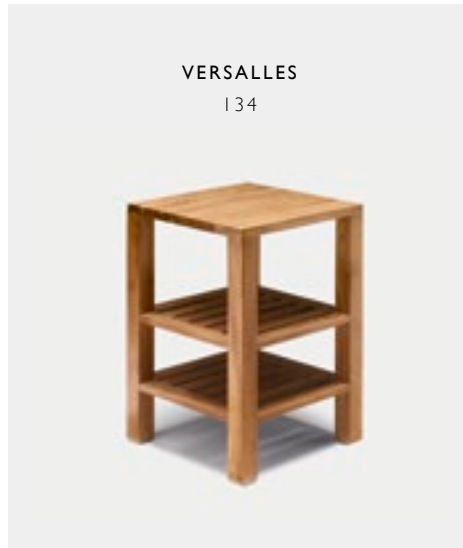

---

BAÑERAS / BATH TUBS

---

SIMI  
116



STONE

---

PLATOS DE DUCHA / SHOWER TRAYS

---

SIMI  
116



OCO  
122

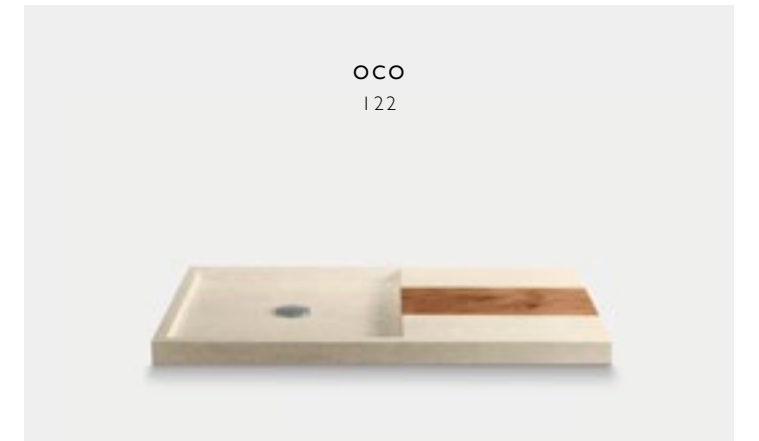

VERONA  
126

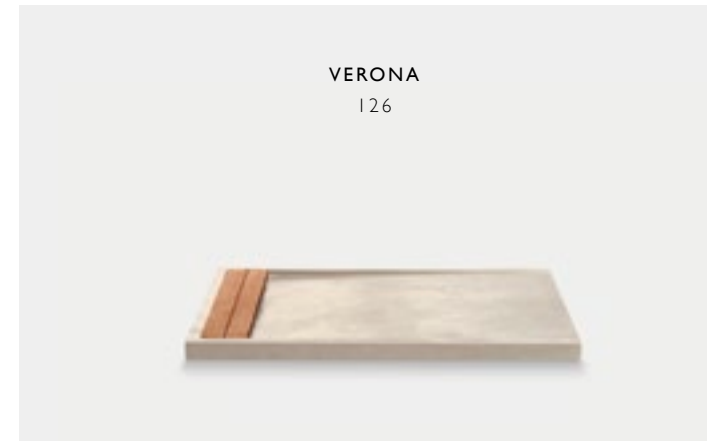

ICONO  
130

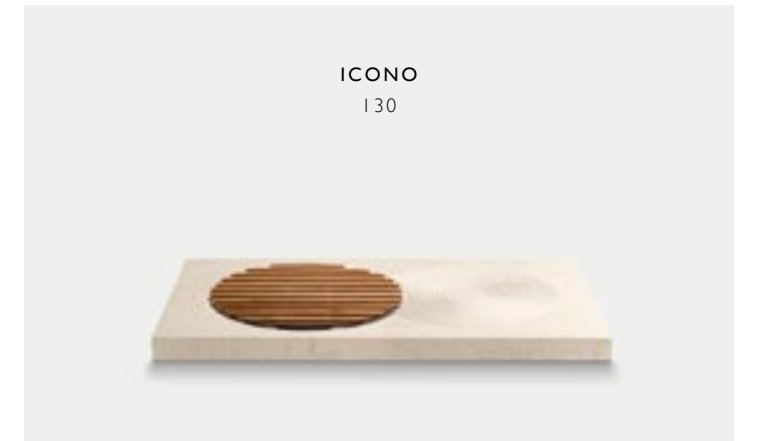

VERSALLES  
134



STONE

# MADAGASCAR

UN DISEÑO PRAGMÁTICO PARA UNA PIEZA QUE EVOCA CONTRASTES, TEXTURAS Y PAISAJES PURAMENTE TERRENALES. LA ELEGANCIA MÁS ORGÁNICA.  
A PRAGMATIC DESIGN FOR A PIECE THAT EVOKES CONTRASTS, TEXTURES AND PURELY TERRESTRIAL LANDSCAPES. THE MOST ORGANIC ELEGANCE.



REF **00383** Beige  
0695\_00

Lavabo / Washbasin  
Ø 420 x H 120



REF 00384 Black  
0695\_00

Lavabo / Washbasin  
Ø 420 x H 120





STONE

# MAURITIUS

UNA SECCIÓN RECTANGULAR CON LAS ARISTAS SUAVIZADAS QUE PROPONE UN DOBLE JUEGO TÁCTIL. EL YING Y EL YANG UNIDOS EN UNA MISMA PIEZA.  
A RECTANGULAR SHAPE WITH SOFTENED CORNERS THAT PROPOSES A DOUBLE TACTILE GAME. YIN AND YANG UNITED IN A SINGLE PIECE.



REF **00385** Beige  
0965\_00

Lavabo / Washbasin  
W 620 x P 350 x H 120



REF **00386** Black  
0965\_00

Lavabo / Washbasin  
W 620 x P 350 x H 120



STONE





STONE

# SEYCHELLES

DE CARCIAS SUAVES EN LA CARA INTERNA Y RUGOSAS EN LA EXTERNA, SEYCHELLES  
RECORTA UN CASQUETE POR EL PARALELO MÁS ESTÉTICO DE LA ESFERA.  
WITH A SOFTLY CARESSED INNER SURFACE AND A ROUGH OUTER SURFACE,  
SEYCHELLES IS A DOME CREATED BY SLICING THE SPHERE AT THE MOST  
AESTHETICALLY PERFECT LONGITUDE.



REF **00379** Beige  
0795\_00

Lavabo / Washbasin  
Ø 420 x H 200



STONE



REF 00380 Black  
0795\_00  
Lavabo / Washbasin  
Ø 420 x H 200



STONE

# REUNIÓN

UN ÓVALO QUE TOMA SU INSPIRACIÓN DEL OCÉANO ÍNDICO, UNA PIEZA QUE APUESTA POR EL ESPACIO, POR AMPLIAR LOS DOMINIOS DEL AGUA.  
AN OVAL THAT TAKES ITS INSPIRATION FROM THE INDIAN OCEAN, A PIECE THAT LAYS CLAIM TO SPACE, TO EXPAND THE DOMAINS OF WATER.



REF 00387 Beige / REF 00388 Black  
0695\_00

Lavabo / Washbasin  
W 450 x P 350 x H 120



REF 00389 Beige / REF 00390 Black  
0895\_00

Lavabo / Washbasin  
W 620 x P 350 x H 120



STONE





STONE

# COMOROS

COMO UN MONOLITO QUE EMERGE DE LAS ENTRAÑAS DE LA TIERRA, COMOROS SE APROXIMA AL USUARIO Y ACERCA A ÉSTE AL RITUAL DIARIO DE LA HIGIENE.  
LIKE A MONOLITH THAT EMERGES FROM THE DEPTHS OF THE EARTH, COMOROS APPROACHES THE USER TO BRING THE DAILY RITUAL OF CLEANSING CLOSER.



REF **00392** Black  
02395\_00  
Lavabo / Washbasin  
W 500 x P 270 x H 900



STONE





REF 00391 Beige  
02395\_00  
Lavabo / Washbasin  
W 500 x P 270 x H 900





STONE

# ZANZIBAR

ZANZIBAR ESCONDE UN DÉJÀ VU ESTÉTICO: A UN DISEÑO YA CONOCIDO SE LE SUMA PIEDRA PULIDA PARA ACENTUAR EL CARÁCTER CÁLIDO DE LOS MINERALES.  
ZANZIBAR HIDES AN AESTHETIC SENSATION OF DÉJÀ VU: POLISHED STONE JOINS A FAMILIAR DESIGN TO ACCENT THE WARM QUALITY OF THE MINERALS.

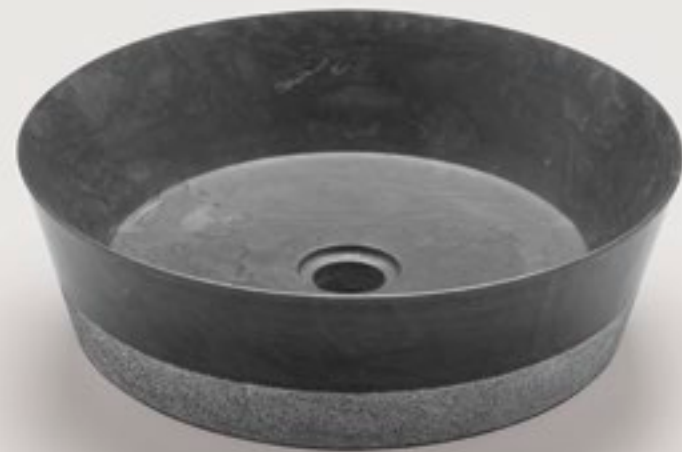

REF 00381 Beige / REF 00382 Black  
0595\_00

Lavabo / Washbasin  
Ø 420 x H 120



STONE





STONE

# SIMI

SIMI ES NUESTRA JOYA DE LA CORONA; UNA COMPLETA  
COLECCIÓN DE PIEZAS PARA SU BAÑO.  
SIMI IS OUR JEWEL IN THE CROWN; A COMPLETE COLLECTION  
FOR YOUR BATHROOM.

COLECCIÓN / COLLECTION

---



REF 00332 Beige / REF 00333 Black  
03985\_00

Mueble lavabo y espejos / Washbasin cabinet and mirrors  
W 1535 x P 450 x H 900

STONE



REF 00336 Beige / REF 00337 Black  
013985\_00

Bañera / Bathtub  
W 2050 x P 800 x H 500



REF 00334 Beige / REF 00335 Black  
02195\_00

Plato de ducha / Shower tray  
W 1200 x P 800 x H 95





STONE

# OCO

UN MUEBLE EN MADERA DE TECA CON LAVABO EN MÁRMOL PULIDO Y  
UN PLATO DE DUCHA EN DOBLE ALTURA, COMPLETAN ESTA HERMOSA COLECCIÓN.  
A TEAK WOOD CABINET WITH POLISHED MARBLE WASHBASIN AND A DOUBLE-HEIGHT  
CEILING SHOWER TRAY COMPLETE THIS BEAUTIFUL COLLECTION.

COLECCIÓN / COLLECTION



REF 00343 Black / REF 00342 Beige  
02695\_00

Mueble lavabo / Washbasin cabinet  
W 1200 x P 500 x H 850



REF 00345 Black / REF 00344 Beige  
02439\_00

Plato de ducha / Shower tray  
W 1400 x P 800 x H 70



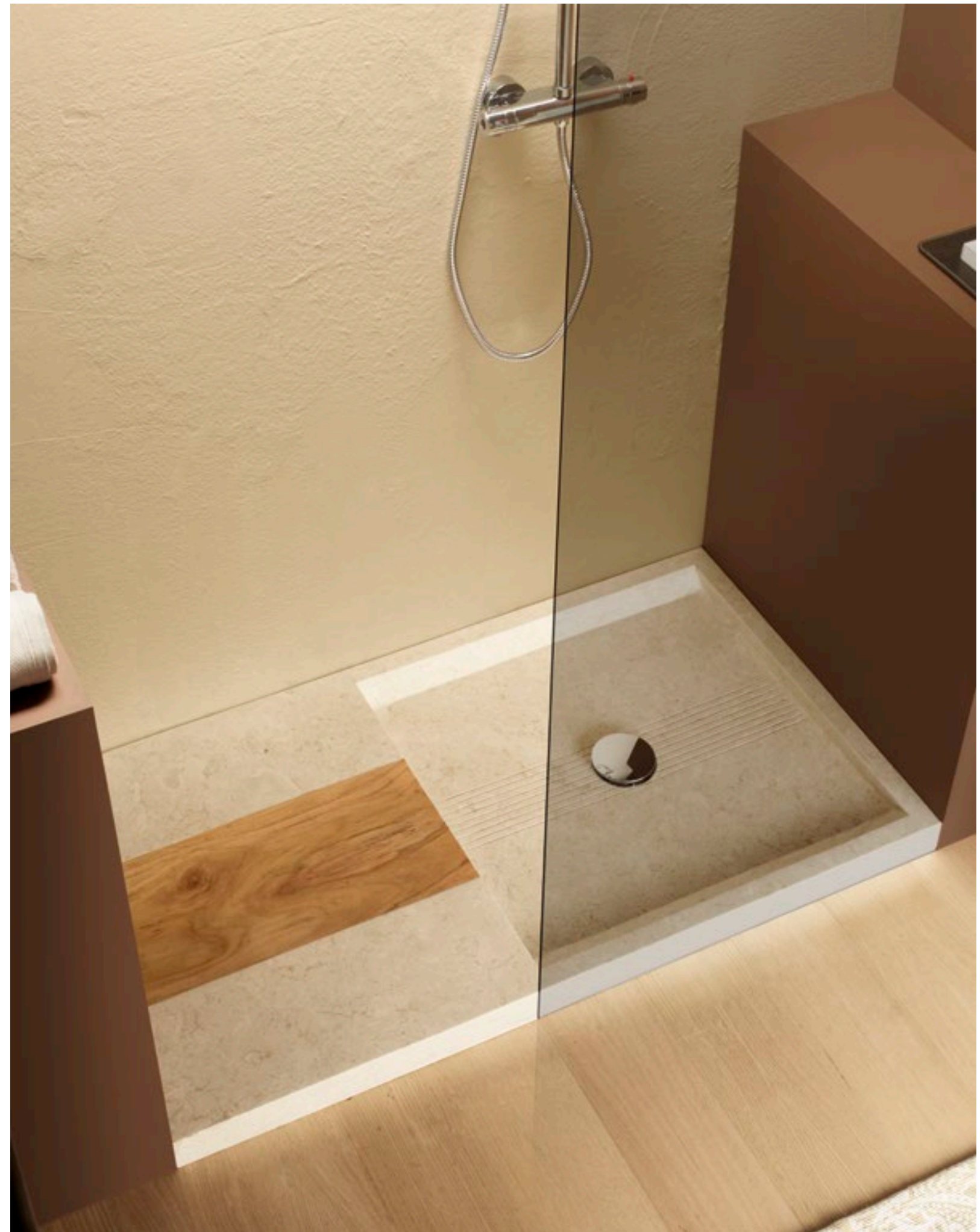

STONE

# VERONA

MUEBLE SUSPENDIDO, PLATO DE DUCHA CON SUPERFICIE REBAJADA...  
DETALLES CARACTERÍSTICOS DE LA MÁS SUTIL DE NUESTRAS COLECCIONES.  
A WALL-HUNG CABINET, A SHOWER TRAY WITH DECREASED AREA,  
CHARACTERISTIC DETAILS OF OUR FINEST COLLECTION.

COLECCIÓN / COLLECTION



REF 00348 Beige  
02439\_00

Mueble lavabo / Washbasin cabinet  
W 800 x P 450 x H 410



REF 00350 Beige  
01695\_00

Plato de ducha / Shower tray  
W 1200 x P 800 x H 50







STONE

# ICONO

EL CÍRCULO ES EL DENOMINADOR COMÚN DE ESTA COLECCIÓN CUYO PLATO DE DUCHA DISPONE DE UNA PRÁCTICA PLATAFORMA EXTRAÍBLE.  
A CIRCLE IS THE COMMON FEATURE OF THIS COLLECTION. THE SHOWER TRAY HAS A PRACTICAL REMOVABLE PLATFORM.

COLECCIÓN / COLLECTION



REF 00339 Black / REF 00338 Beige  
0585\_85

Lavabo / Washbasin  
W 400 x P 450 x H 100

REF 00331  
0414\_85

Pedestal con toallero /  
Pedestal with towel rail  
W 265 x P 400 x H 750



REF 00340 Beige  
02439\_00

Plato de ducha / Shower tray  
W 1400 x P 800 x H 70





STONE

## VERSALLES

CÍRCULOS Y CUADRADOS, UNA PERFECTA COMBINACIÓN DE FORMAS REGULARES EN ARMONÍA.  
CIRCLE AND SQUARE SHAPES, A PERFECT AND HARMONIOUS COMBINATION.

COLECCIÓN / COLLECTION



REF 00354 Beige / REF 00355 Black  
0619\_00

Lavabo / Washbasin  
W 400 x P 400 x H 150

REF 00356  
01119\_00

Mueble / Cabinet  
W 500 x P 500 x H 750



REF 00352 Beige / REF 00353 Black  
01309\_00

Plato de ducha / Shower tray  
W 908 x P 908 x H 50





STONE

# CALABRIA

HERMOSA PIEZA DE MÁRMOL HORADADA EN SU CENTRO, SOBRE  
UN PRÁCTICO MUEBLE EN MADERA DE TECA.  
A BEAUTIFUL MARBLE PIECE CARVED IN ITS CENTER ON TOP OF A  
PRACTICAL TEAK WOOD CABINET.



REF 00347 Black / REF 00346 Beige  
03985\_00

Mueble lavabo / Washbasin cabinet  
W 800 x P 480 x H 900

STONE



STONE

# MIRAGE

UNA SOBRIA PIEZA EN DOBLE ACABADO; ABUJARDADO EXTERIOR  
Y ZONA DE AGUAS EN MÁRMOL PULIDO MATE.  
A SIMPLE PIECE WITH TWO FINISHES: AN EXTERNAL ROUGH GROOVED  
SURFACE AND A MATT POLISHED INNER POOL.



REF 00374 Black / REF 0373 Beige  
0582\_95

Lavabo / Washbasin  
Ø 400 x H 300



STONE

# VULKA

SINGULAR COMBINACIÓN ASIMÉTRICA DE DOS PIEZAS EN UNA QUE  
CONFORMAN ESTE BELLO LAVABO EN DOBLE TONO.  
A SINGULAR ASYMMETRIC COMBINATION OF TWO PIECES IN ONE,  
THAT DEFINES THIS BEAUTIFUL BICOLOURED WASHBASIN.



REF 00369 Beige / REF 00370 Black  
0867\_00

Lavabo / Washbasin  
W 800 x P 450 x H 190

STONE





STONE

## DUOTONO A

SENCILLA Y BELLA PIEZA DE MÁRMOL PULIDO MATE DE DOBLE TONALIDAD, CON FORMA ESENCIAL.  
A SIMPLE AND DELICATED MARBLE PIECE, BICOLOURED MATT POLISHED FINISH WITH AN ESSENTIAL FORM.



REF 00362 Black / REF 00361 Beige  
0489\_00

Lavabo / Washbasin  
Ø 450 x H 120

STONE





STONE

## DUOTONO B

EQUILIBRADA PIEZA EN FORMA DE CONO TRUNCADO, ACABADA EN MÁRMOL PULIDO MATE DE DOBLE TONALIDAD.  
A BALANCED MARBLE PIECE, BICOLOURED CONE SHAPE IN POLISHED MATT FINISH.



REF 00365 Beige / REF 00366 Black  
0489\_00

Lavabo / Washbasin  
Ø 410 x H 150



STONE

# COPLATO

PIEZA CUYA SINGULARIDAD RESIDE EN LA BANDA CENTRAL  
RESULTANTE DE LA COMBINACIÓN DE DOS TONOS.  
THE PECULIARITY OF THIS PIECE CONSISTS IN THE CONTRAST OF A CENTRAL  
STRIPE WHICH IS THE RESULT OF TWO COLOURS COMBINATION.



REF 00363 Beige / REF 00364 Black  
0519\_00

Lavabo / Washbasin  
Ø 450 x H 120

STONE





STONE

# MONTENEGRO

ORIGINAL ENSAMBLE DE LÁMINAS DE MÁRMOL EN DOBLE TONO Y ACABADO:  
PULIDO MATE EN LA ZONA DE AGUAS Y EN BRUTO SOBRE TODO SU PERÍMETRO.  
AN ORIGINAL UNION OF MARBLE LAYERS IN TWO COLOURS AND FINISHES:  
A MATT POLISHED INNER POOL AND ROUGH SURFACE IN ALL ITS PERIMETER.



REF 00368 Black / REF 00367 Beige  
0598\_00

Lavabo / Washbasin  
W 450 x P 450 x H 100

STONE

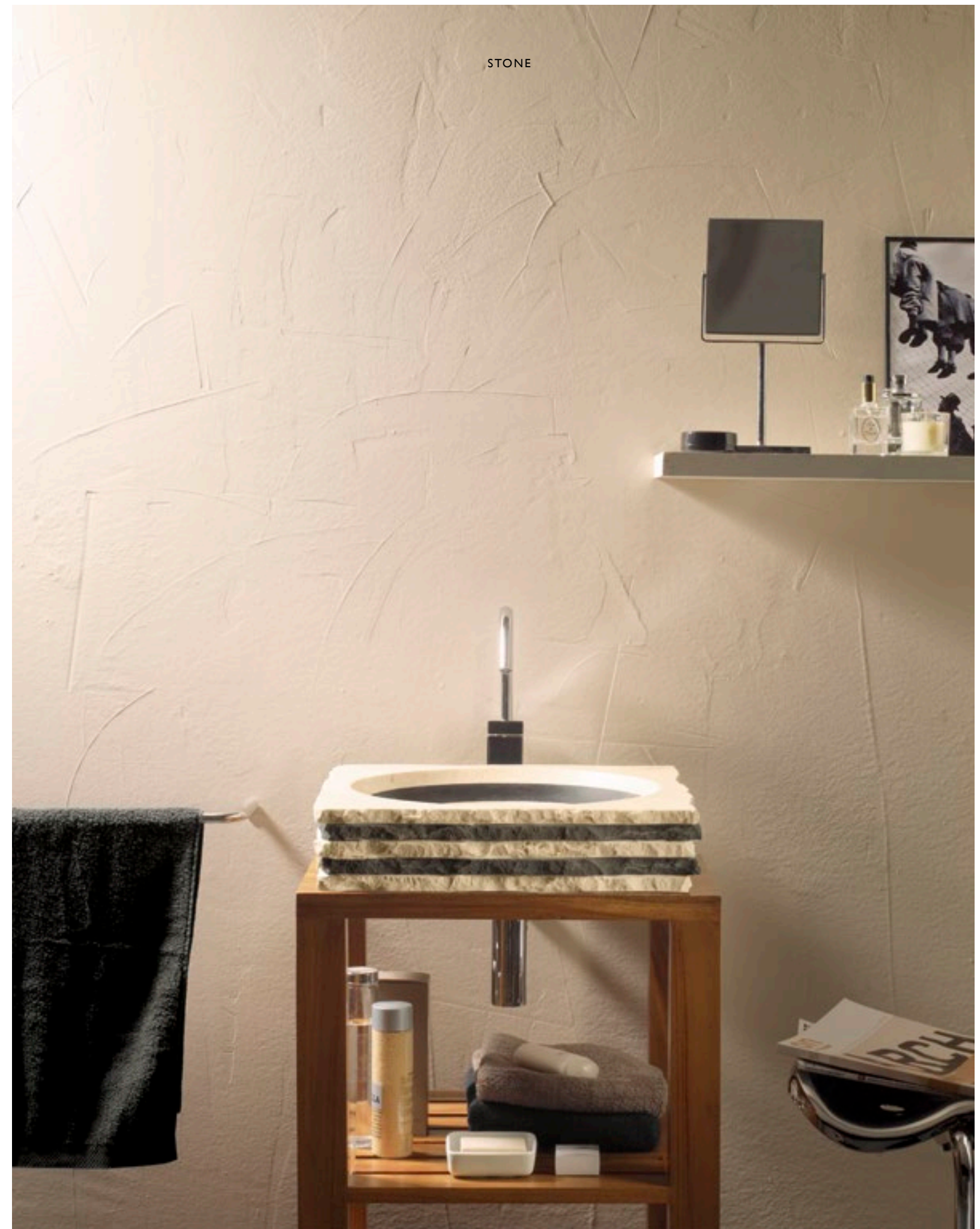

STONE

## AROS

LA MÁS COMPLEJA DE NUESTRAS PIEZAS SINGULARES; DELICADA EN LA COMBINACIÓN DE MATERIALES Y EXQUISITA EN SUS FORMAS.  
THE MOST COMPLEX PIECE WITHIN THE COLLECTION; DELICATED IN THE COMBINATION OF THE MATERIALS AND REFINED SHAPES.



REF 00371 Beige / REF 00372 Black  
01095\_00

Lavabo / Washbasin  
W 800 x P 450 x H 100

STONE



STONE

## LUNGO SQUARE

COLUMNA DE FORMA CONTUNDENTE Y PRECISA EN SUS ARISTAS,  
LIGERAMENTE INCLINADA PARA FACILITAR EL ACCESO A LA PILA.  
A ROBUST COLUMN OF PRECISE EDGES, SLIGHTLY LEANING TOWARDS TO  
FACILITATE THE ACCESS TO THE POOL.



REF 00358 Beige / REF 00359 Black  
01895\_95

Lavabo / Washbasin  
W 410 x P 485 x H 1000

STONE







STONE

# FIJI

ORIGINAL PIEZA MONOBLOQUE CUYO ESTRIADO ACABADO EXTERIOR VA CERRÁNDOSE SOBRE LA ZONA DE AGUAS EN MÁRMOL PULIDO MATE.  
AN ORIGINAL MONOBLOCK PIECE WITH STRIATED EXTERNAL FACE AND POLISHED INNER SIDE.



REF 00315 Black / REF 00316 Beige  
0565\_95

Lavabo / Washbasin  
Ø 450 x H 150



# 3

## CEMENT & TERRAZZO

---

Cement & Terrazzo homenajea a la lava pétreo, a sus grises elegantes y a esas texturas casi mates de los paisajes volcánicos. La serie reivindica también las formas puras y geométricas, y es de ese contraste de donde nacen unas piezas con una capacidad de combinación casi universal. Los colores gris y ceniza están dotados de una distinción especial.

Cement & Terrazzo is an homage to petrified lava, to its elegant greys and the almost matte textures of volcanic landscapes. The series also honours pure and geometric forms, and it is from this contrast that a group of pieces are born with a nearly universal capacity for combination. The grey and ash colours are imbued with special distinction.

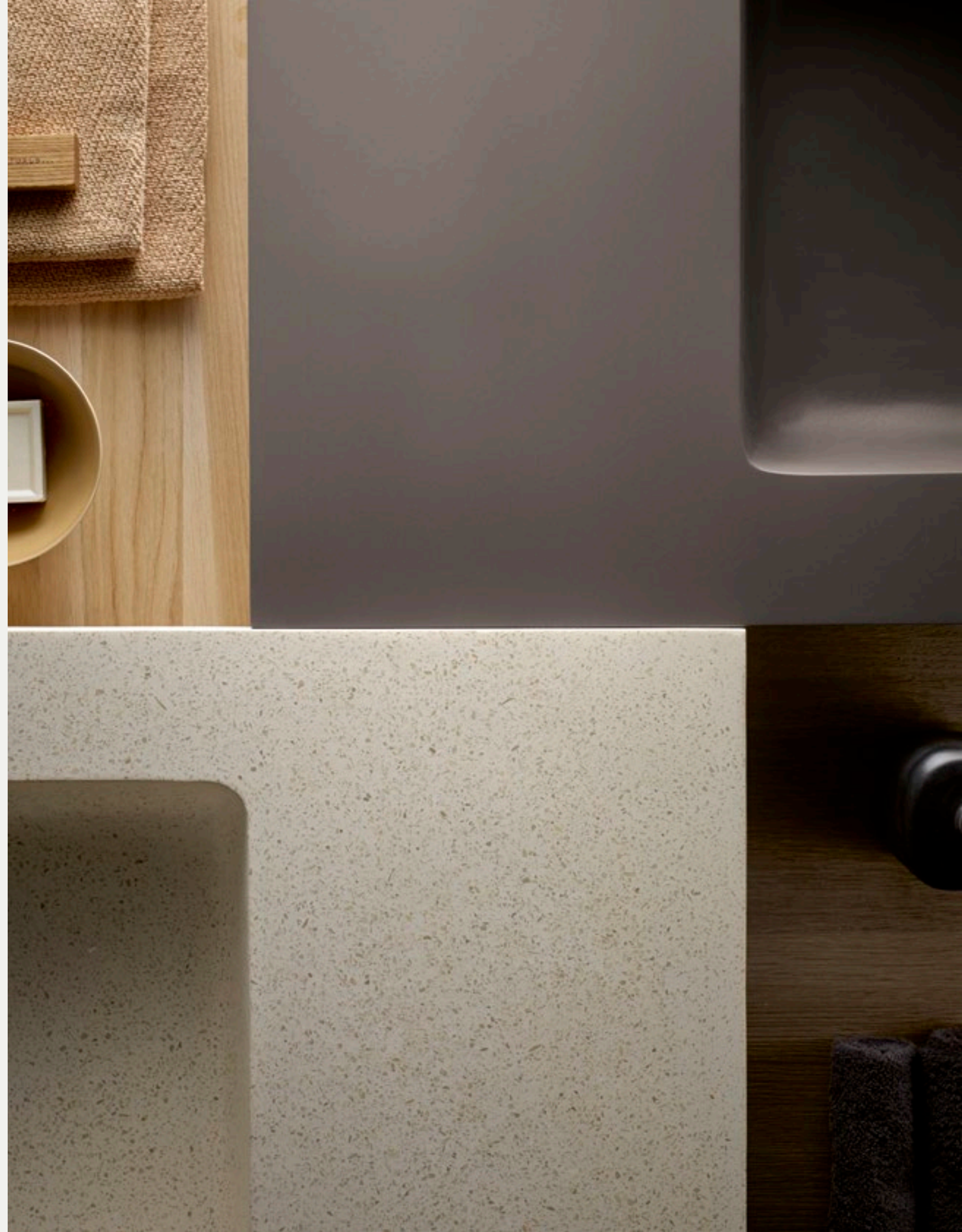

# PRODUCT INDEX

## LAVABOS / WASHBASINS

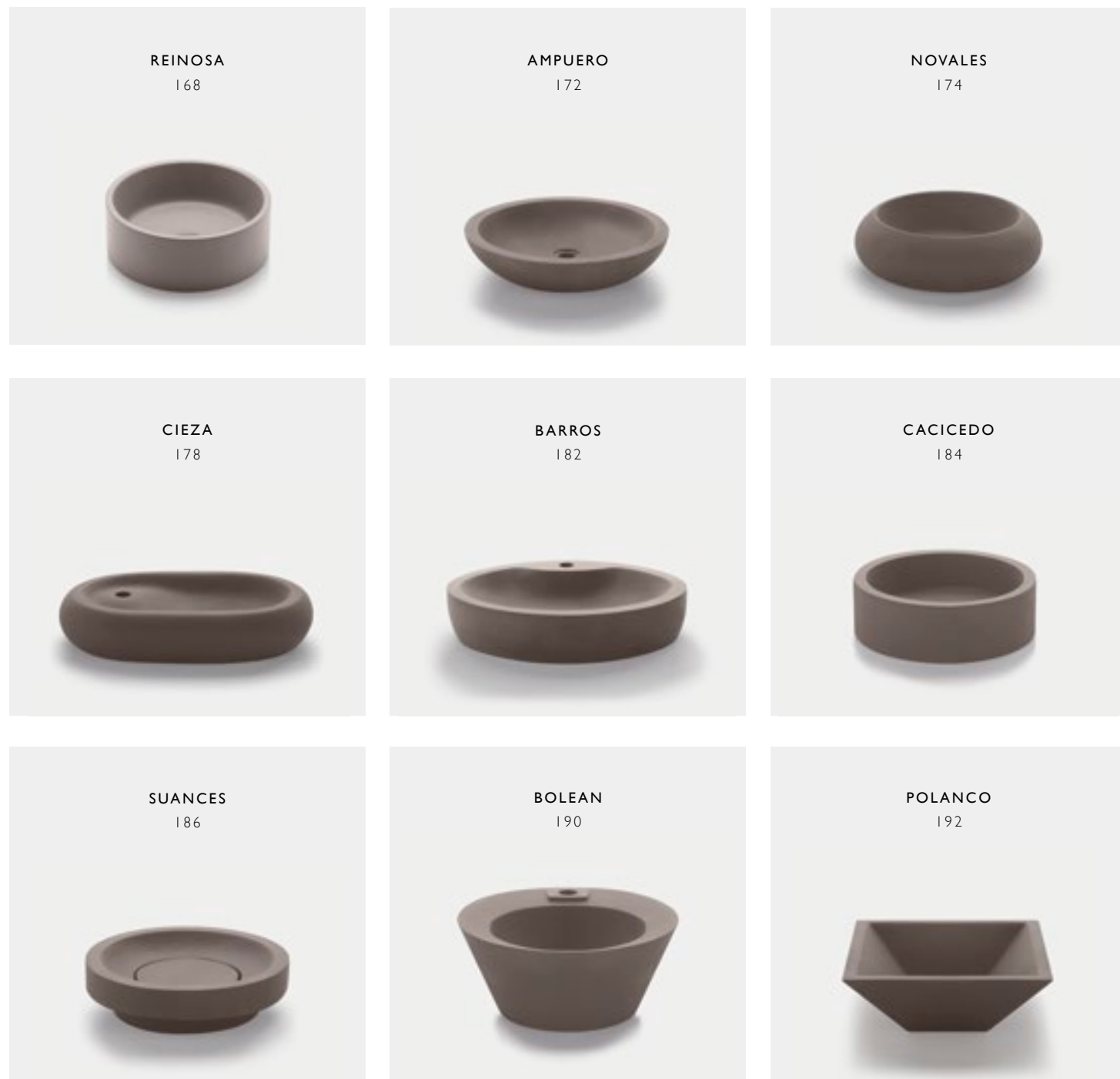

## LAVABOS / WASHBASINS



CEMENT & TERRAZZO

# REINOSA

LA BELLEZA Y LA PERFECCIÓN DEL CILINDRO PLASMADA EN UNA PIEZA. REINOSA  
ARMONIZA LOS ESPACIOS GRACIAS A UNA GEOMETRÍA SOBRIA Y UNIVERSAL.  
THE BEAUTY AND IMPERFECTION OF THE CYLINDER EXPRESSED IN A SINGLE PIECE.  
REINOSA HARMONISES SPACES THANKS TO A SOBER AND UNIVERSAL GEOMETRY.



REF **08038** Cement  
0389\_00

Lavabo / Washbasin  
Ø 420 x H 120





CEMENT & TERRAZZO

# AMPUERO

AMPUERO ES DISEÑO ESENCIAL Y CONTUNDENCIA EN LOS PERFILES. ES FUNCIÓN SUPEDITADA A LA FORMA, LA AUSTERIDAD ELEVADA A LA MÁXIMA POTENCIA.  
AMPUERO IS ESSENTIAL DESIGN WITH ROBUST CONTOURS. IT IS FUNCTION AT THE SERVICE OF FORM, AUSTERITY ELEVATED TO ITS HIGHEST EXPRESSION.



REF **08004** Cement  
0349\_00

Lavabo / Washbasin  
Ø 500 x H 110



CEMENT & TERRAZZO

# NOVALES

NOVALES NO ES UNA EXCEPCIÓN. ES LA EXCEPCIÓN. UNA PIEZA QUE EVOCA PROCESOS ARTESANOS Y, A LA VEZ, INVITA A SER ACARICIADA.  
NOVALES IS NOT AN EXCEPTION. IT IS THE EXCEPTION. A PIECE THAT EVOKES ARTISANAL PROCESSES AND, AT THE SAME TIME, ASKS TO BE CARESSSED.



REF **08008** Cement  
0349\_00

Lavabo / Washbasin  
Ø 450 x H 130







CEMENT & TERRAZZO



REF **08007** Terrazzo  
0349\_00  
Lavabo / Washbasin  
Ø 450 x H 130

CEMENT & TERRAZZO

# CIEZA

SIN ARISTAS VIVAS, SIN ÁNGULOS QUE COMPROMETAN SU PUREZA. CIEZA ES PIEDRA CÁLIDA DE PERFILES SUAVES, COMO LOS CANTOS DE UN RÍO TALLADOS POR LA ACCIÓN DEL AGUA.

WITH NO SHARP CORNERS, NO ANGLES TO COMPROMISE ITS PURITY. CIEZA IS WARM STONE WITH SOFT CONTOURS, LIKE RIVER STONES SCULPTED BY THE ACTION OF THE WATER.



REF **0801** | Terrazzo  
0459\_00

Lavabo / Washbasin  
W 600 x P 380 x H 120





REF **08012** Cement  
0459\_00  
Lavabo / Washbasin  
W 600 x P 380 x H 120

CEMENT & TERRAZZO

# BARROS

TRADICIÓN Y MODERNIDAD. CLASICISMO Y VANGUARDIA. ÁNGULOS Y CURVAS.  
BARROS REIVINDICA LA DUALIDAD, LA HERMANDAD DE CONCEPTOS CONTRARIOS.  
TRADITION AND MODERNITY. CLASSICISM AND AVANT GARDE. ANGLES AND  
CURVES. BARROS HONOURS DUALITY, THE FELLOWSHIP OF OPPOSING CONCEPTS.

---

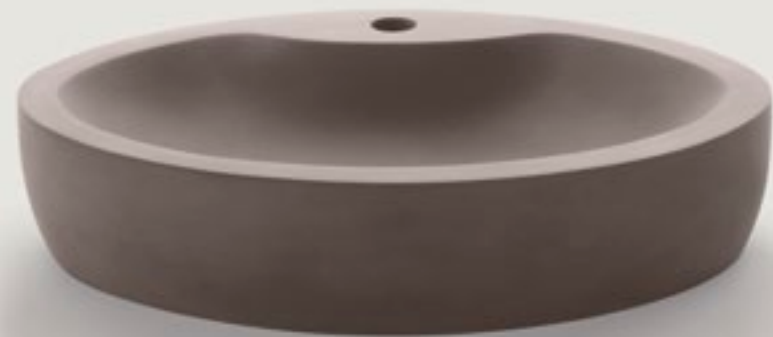

REF **08014** Cement  
0439\_00

Lavabo / Washbasin  
W 550 x P 400 x H 120

---



CEMENT & TERRAZZO

# CACICEDO

CACICEDO EMBELLECE LAS ESTANCIAS Y LO HACE CON SENCILLEZ. EVOCA LAS FORMAS MÁS PURAS DE UNA NATURALEZA QUE NO HA SIDO DOMADA.  
CACICEDO EMBELLISHES ROOMS AND DOES IT WITH SIMPLICITY. IT EVOKES THE PUREST FORMS OF A NATURE THAT HAS YET TO BE TAMED.



REF **08006** Cement  
0349\_00

Lavabo / Washbasin  
Ø 420 x H 130



CEMENT & TERRAZZO

# SUANCES

SUANCES JUEGA CON EL DINAMISMO Y LAS FORMAS AUSTERAS. HUYE DE LO ESTABLECIDO PARA CREAR ALGO ABSOLUTAMENTE NUEVO EN CONTINUA EXPANSIÓN.  
SUANCES PLAYS WITH DYNAMISM AND AUSTERE FORMS. IT BYPASSES CONVENTION TO CREATE SOMETHING TOTALLY NEW IN A STATE OF PERPETUAL EXPANSION.

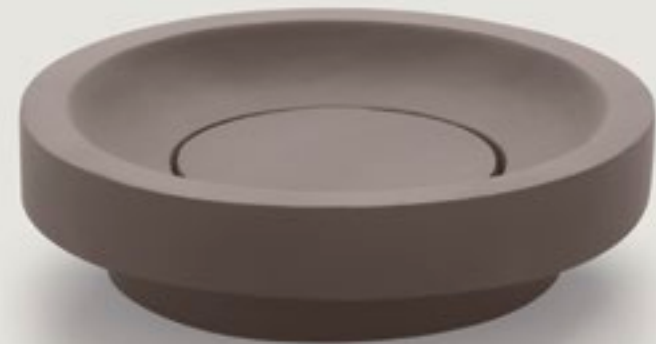

Lavabo / Washbasin  
Ø 400 x H 110

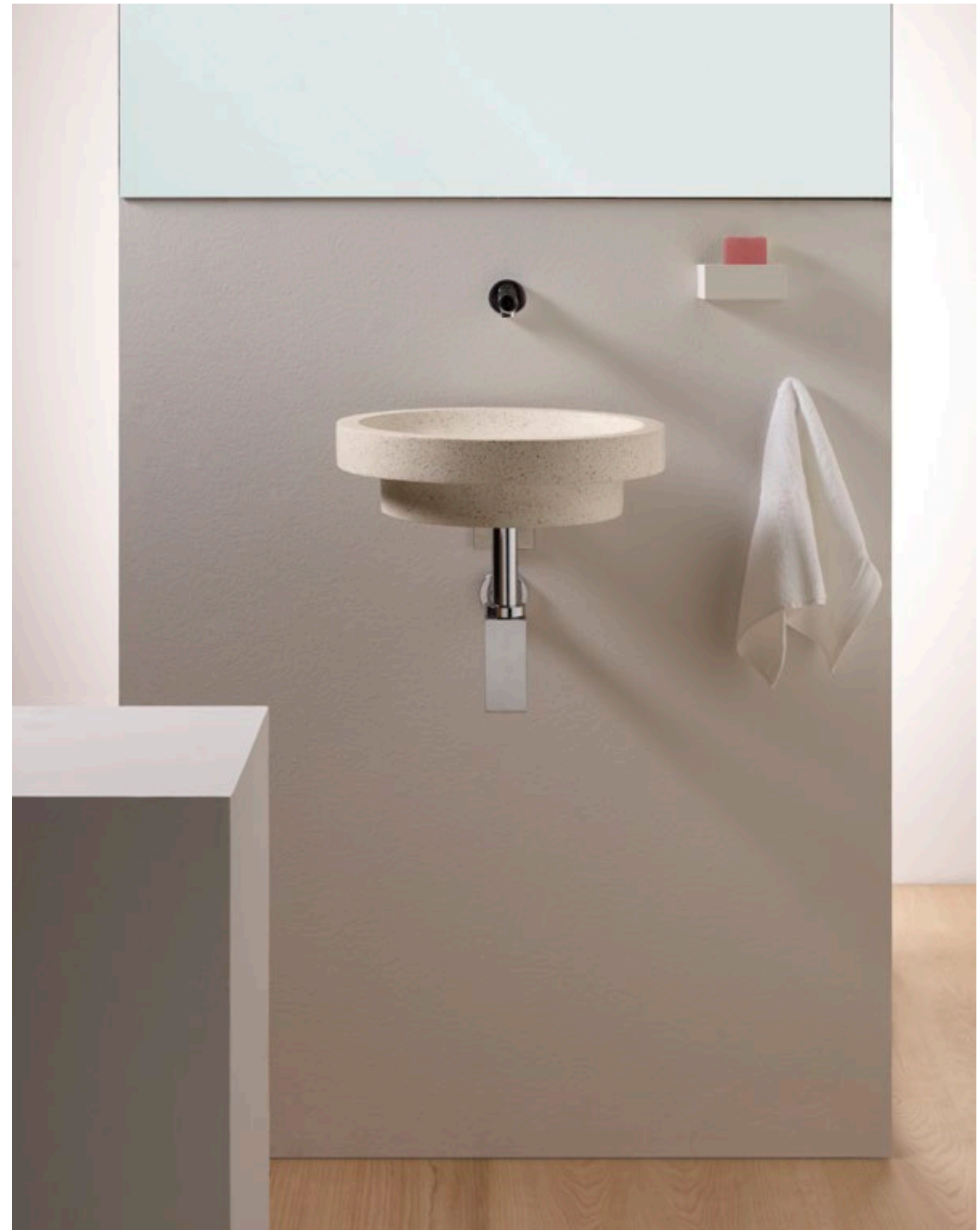

REF 08033 Terrazzo  
0419\_00  
Lavabo / Washbasin  
Ø 400 x H 110



CEMENT & TERRAZZO

# BOLEAN

EL MODELO CÓNICO MÁS COMPLEJO DE NATURAL SERIES, CREADO PARA SINGULARIZAR LOS AMBIENTES Y LAS RUTINAS. SÓLO BOLEAN CREA UN VACÍO A PARTIR DE VOLUMINOSAS PAREDES.

THE MOST COMPLEX CONICAL MODEL OF THE NATURAL SERIES, CREATED TO MAKE ENVIRONMENTS AND ROUTINES DISTINCTIVE. ONLY BOLEAN CREATES A CAVITY OUT OF THICK WALLS.



REF 08001 Terrazzo / REF 08002 Cement  
0396\_00

Lavabo / Washbasin  
Ø 430 x H 180





CEMENT & TERRAZZO

# POLANCO

POLANCO ES GEOMETRÍA CLÁSICA, ES UNA PIRÁMIDE INVERTIDA CON LA CÚSPIDE TRUNCADA. TAN SENCILLA Y TAN COMPLEJA A LA VEZ.  
POLANCO IS CLASSICAL GEOMETRY, AN INVERTED PYRAMID WITH A TRUNCATED APEX. SIMPLE AND COMPLEX AT THE SAME TIME.



REF 08022 Cement / REF 08021 Terrazzo  
0248\_00

Lavabo / Washbasin  
W 400 x P 400 x H 150



CEMENT & TERRAZZO

# SARÓN

UN REGRESO A LA ESENCIA, UN DISEÑO QUE PARTE DE UNA SUPERFICIE MÍNIMA EN LA BASE HASTA EXPANDIRSE EN LA COPA. SARÓN ES SÓLO UN CONO. LIMPIO, TRUNCADO Y PERFECTO.

A RETURN TO ESSENCE, A DESIGN THAT STARTS FROM A MINIMAL FOOTPRINT AT THE BASE AND EXPANDS TO FORM A BOWL. SARÓN IS A SIMPLE CONE. CLEAN, TRUNCATED AND PERFECT.



REF **08010** Cement  
0248\_00

Lavabo / Washbasin  
Ø 405 x H 160



REF 08009 Terrazzo

0248\_00

Lavabo / Washbasin  
Ø 405 x H 160



CEMENT & TERRAZZO

# CAMARGO

CAMARGO PODRÍA SER UNA OBRA DE LA NATURALEZA, UNA ESCULTURA EN LA QUE SE FUNDEN DOS DISEÑOS. UN CRUCE DE CAMINOS EN FAVOR DE LA FUNCIONALIDAD.  
CAMARGO COULD BE A WORK OF NATURE, A SCULPTURE THAT FUSES TWO DESIGNS. A CROSSROADS WHERE FUNCTIONALITY IS THE ROAD TAKEN.



REF 08031 Terrazzo / REF 08032 Cement  
0589\_00

Lavabo / Washbasin  
W 800 x P 530 x H 110



CEMENT & TERRAZZO

# PARBAYÓN

PARBAYÓN TIENE EL SECRETO DE LA ATEMPORALIDAD: LA SENCILLEZ GEOMÉTRICA DE LOS PLANOS RECTOS Y CURVOS. TODO AL SERVICIO DE UN LAVABO ICÓNICO.  
PARBAYÓN HAS THE SECRET OF TIMELESSNESS: THE GEOMETRIC SIMPLICITY OF THE STRAIGHT AND CURVED PLANES. ALL AT THE SERVICE OF AN ICONIC WASHBASIN.



REF **08015** Terrazzo / REF **08016** Cement  
0429\_00

Lavabo / Washbasin  
W 500 x P 500 x H 120



CEMENT & TERRAZZO

# BERANGA

COMO SI FUERA UNA LAGUNA CREADA NATURALMENTE, BERANGA ES UN CANTO A LA ASIMETRÍA. SUS FORMAS ORGÁNICAS CONTRIBUYEN A LA PAZ VISUAL.  
LIKE A NATURALLY OCCURRING LAGOON, BERANGA IS A ODE TO ASYMMETRY. ITS ORGANIC FORMS CONTRIBUTE TO VISUAL PEACE.



REF **08017** Terrazzo  
0598\_00  
Lavabo / Washbasin  
W 800 x P 450 x H 120



REF **08018** Cement  
0598\_00  
Lavabo / Washbasin  
W 800 x P 450 x H 120

CEMENT & TERRAZZO

# PREZANES

TOMANDO COMO REFERENCIA LOS DISEÑOS IMPERECEDEROS, PREZANES CREA ALGO NUEVO. UNA PILA DINÁMICA QUE APUESTA POR UNA PRÁCTICIDAD CLÁSICA. PREZANES TAKES ENDURING DESIGNS AS A REFERENCE AND CREATES SOMETHING NEW. A DYNAMIC WASHBASIN THAT SETS ITS SIGHTS ON CLASSICAL PRACTICALITY.



REF **08023** Terrazzo  
0679\_00

Lavabo / Washbasin  
W 900 x P 410 x H 140



CEMENT & TERRAZZO

# SOBARZO

SOBARZO ES ALGO NUEVO Y, A LA VEZ, NO LO ES. TOMA LA MANO DE LA TRADICIÓN Y LA REACTUALIZA SUTILMENTE PARA OFRECER UN VALOR SEGURO.  
SOBARZO IS SOMETHING NEW AND, AT THE SAME TIME, IS NOTHING OF THE KIND. IT TAKES TRADITION BY THE HAND AND SUBTLY REINTERPRETS IT TO OFFER SURE VALUE.



REF **08020** Cement  
0379\_00

Lavabo / Washbasin  
W 500 x P 450 x H 80





CEMENT & TERRAZZO

# POTES

POTES ES UN ÚNICO DISEÑO CON MUCHAS LECTURAS DIFERENTES: ACEPTA VARIACIONES EN EL ANCHO DEL ALA, EN EL NÚMERO DE POZAS Y EN SU SOPORTE. MENOS VUELVE A SER MÁS, MUCHO MÁS.

POTES IS A UNIQUE DESIGN WITH NUMEROUS READINGS: IT ACCEPTS VARIATIONS IN THE WIDTH OF THE WINGS, THE NUMBER OF SINKS AND IN ITS BASE. LESS ONCE AGAIN BECOMES MORE, MUCH MORE.



REF **08025** Terrazzo / REF **08026** Cement  
0529\_00

Lavabo / Washbasin  
W 800 x P 510 x H 130



REF **08028** Cement  
0638\_00

Lavabo / Washbasin  
W 1000 x P 510 x H 130



REF **08027** Terrazzo  
0638\_00

Lavabo / Washbasin  
W 1000 x P 510 x H 130



REF **08030** Cement  
0986\_00

Lavabo / Washbasin  
W 1200 x P 510 x H 130

REF **08029** Terrazzo  
0986\_00

Lavabo / Washbasin  
W 1200 x P 510 x H 130

# 4

## WOOD

---

La madera es el material constructivo más antiguo conocido. Todo comenzó con ella, todo sigue igual con ella, con su belleza y su nobleza. Hablar de madera es hablar de hogar, de calidez, de cercanía, de la más sencilla de todas las elegancias. La serie Wood, en madera de Teka, nos recuerda nuestros orígenes, cuán gozoso es volver a ellos y añade una atmósfera de refinamiento a los baños.

Wood is the oldest building material known to man. Everything started there, it remains unchanged, with its beauty and its nobility. To talk about wood is to talk about home, warmth, familiarity, about the simplest of all elegances. The Wood series, in teak, reminds us of our origins, of how wonderful it feels to return to them, and adds an atmosphere of refinement to bathrooms.

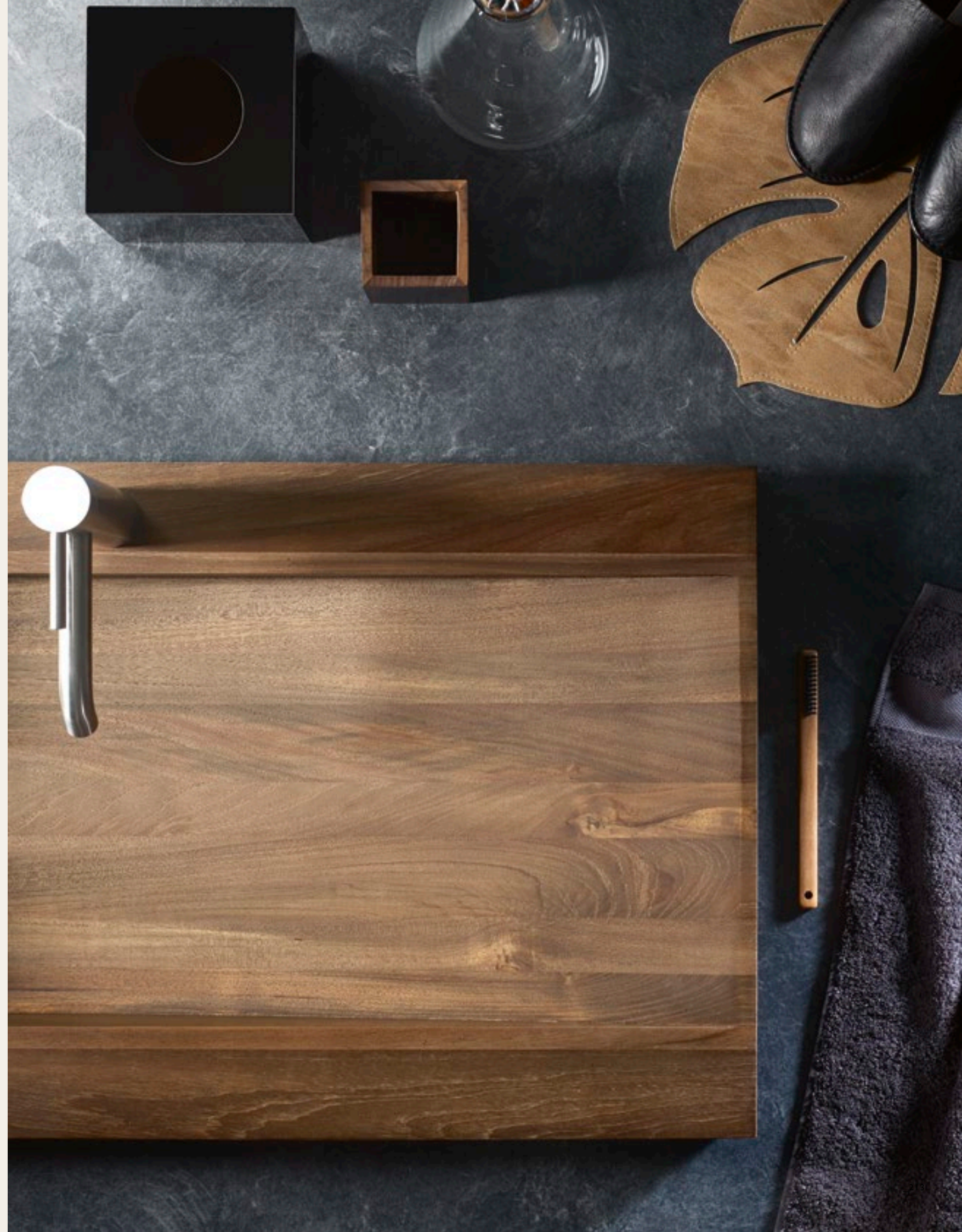

WOOD

## PRODUCT INDEX

---

LAVABOS / WASHBASINS

---

SALZBURGO  
222



BERNA  
220



RIBE  
228



BERNA  
216



BERGEN  
226



WOOD

# BERNA

BERNA MIRA HACIA EUROPA Y RESCATA DE ÉSTA LOS TRABAJOS EN MADERA DE TEKA MÁS CONTEMPORÁNEOS. LÍNEAS SIMPLES Y GEOMETRÍAS FRESCAS.  
BERNA LOOKS TO EUROPE AND RECOVERS THE MOST CONTEMPORARY WORKS IN TEAK. SIMPLE LINES AND FRESH GEOMETRIES.



REF 5002  
02389\_00

Encimera con patas y toallero / Top with legs and towel rail  
W 1100 x P 500 x H 745

WOOD





bathco

bathco

WOOD

# BERNA

BERNA ES CAPAZ DE EVOLUCIONAR HACIA ESQUEMAS MÁS ELEMENTALES,  
MANTENIENDO SU ESENCIA PERO PRESCINDIENDO DE LO ACCESORIO. LIGERA  
COMO UNA AVE

BERNA IS CAPABLE OF EVOLVING TOWARDS MORE ELEMENTAL SCHEMAS, MAINTAINING  
ITS ESSENCE WHILE MAKING ACCESSORIES SUPERFLUOUS. LIGHT LIKE A BIRD.



REF 5001  
01596\_00

Encimera con toallero / Top with towel rail  
W 1100 x P 500 x H 50

WOOD



WOOD

# SALZBURGO

ES RARA LA GEOGRAFÍA EN LA QUE NO ESTÁN PRESENTES LA MADERA Y EL AGUA.  
SE COMPLEMENTAN, SE NECESITAN, SE RELACIONAN. SALZBURGO PERMITE EL  
REENCUENTRO DE AMBAS.

RARE IS THE GEOGRAPHY WITHOUT WOOD AND WATER. THEY COMPLEMENT EACH  
OTHER, NEED EACH OTHER, RELATE TO ONE ANOTHER. SALZBURGO REUNITES THEM.



REF 5003  
02598\_00

Lavabo doble poza con toallero / Double washbasin with towel rail  
W 1200 x P 450 x H 90

WOOD







WOOD

# BERGEN

LAS ESTRUCTURAS COMO BERGEN NO SÓLO BRILLAN POR SI MISMAS SINO QUE SON CAPACES DE DINAMIZAR EL RESTO DE PIEZAS QUE LAS ACOMPAÑAN EN LA ESTANCIA  
STRUCTURES LIKE BERGEN NOT ONLY SHINE WITH THEIR OWN LIGHT, THEY ARE CAPABLE OF MAKING THE PIECES AROUND THEM MORE DYNAMIC.



REF 5005  
01289\_00

Escalera toallero espejo / Mirrored towel rail  
W 450 x H 1920

WOOD



WOOD

## RIBE

DEL CONTRASTE ENTRE LA PORCELANA Y LA MADERA, ENTRE LA CURVA Y LA RECTA, ENTRE LO PÁLIDO Y LO TOSTADO, NACE UNA PIEZA CUYO ENCANTO ES SU SAGACIDAD. ELEGANTE PERO DISCRETA.

FROM THE CONTRAST BETWEEN PORCELAIN AND WOOD, BETWEEN THE CURVE AND THE STRAIGHT LINE, BETWEEN PALE AND TOASTED HUES, COMES A PIECE WHOSE CHARM IS IN ITS WISDOM. ELEGANT YET DISCREET.



REF 5004  
1976\_00

Encimera con lavabo de porcelana Volta 35 /  
Top with porcelain washbasin volta 35  
W 1000 x P 480 x H 100

WOOD





# 5

## MICROCEMENT

---

La serie Microcement introduce nuevos aires en el baño, nuevos tonos y texturas capaces de adaptarse a espacios más atrevidos. Sus piezas reivindican formas orgánicas, detalles y formas que a la Naturaleza le habría costado siglos plasmar. Visten tonos grises (claros y oscuros), tejas y óxidos que evocan el envejecimiento de los metales nobles.

The Microcement series brings new airs into the bathroom, new tones and textures capable of adapting to the boldest spaces. Its pieces honour organic forms, details and shapes that nature has taken centuries to come up with. Dressed in greys (light and dark), terracottas and rusts that evoke the ageing of noble metals.



## PRODUCT INDEX

---

### LAVABOS / WASHBASINS

---



MICROCEMENT

# SICILIA

PARTIENDO DE LAS HECHURAS DE UNA FINA PIEZA DE ARTESANÍA, SICILIA EVOCA TEXTURAS Y COLORES INDOMABLES PRESENTES EN UN PAISAJE MEDITERRÁNEO IDÍLICO.

STARTING WITH THE BEWITCHING QUALITIES OF A FINE ARTISANAL PIECE, SICILIA EVOKES THE INDOMITABLE TEXTURES AND COLOURS OF AN IDYLIC MEDITERRANEAN LANDSCAPE.



REF 1501MC Teja  
0695\_00

Lavabo / Washbasin  
Ø 400 x H 150



REF 1502MC Gris Claro  
0695\_00

Lavabo / Washbasin  
Ø 400 x H 150

MICROCEMENT









REF 1503MC Gris Oscuro  
0695\_00

Lavabo / Washbasin  
Ø 400 x H 150



REF 1504MC Oxido  
0795\_00

Lavabo / Washbasin  
Ø 400 x H 150





PRODUCT INDEX

---

**SOLID SURFACE**

P. 246

**STONE**

P. 252

**CEMENT & TERRAZZO**

P. 258

**WOOD**

P. 260

**MICROCEMENT**

P. 262

---

**BELTED**  
20



REF **6015**  
0279\_85

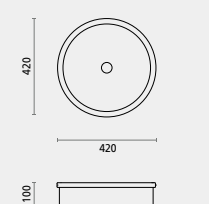

**UMBRÍA**  
26



REF **6016**  
0268\_95

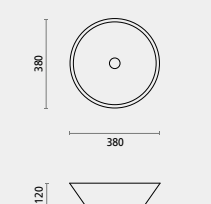

**TRIESTE**  
22



REF **6017**  
0299\_85

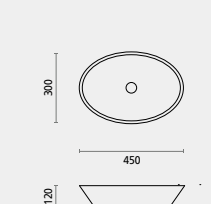

**NANSA**  
68



REF **6008**  
0476\_00



**NANSA**  
69



REF **6008 / 0301**  
01095\_00



**NANSA**  
71



REF **6009**  
0559\_00

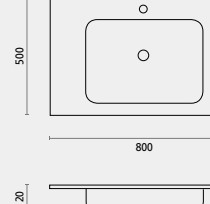

**POLARIS**  
52



REF **6001**  
0136\_00

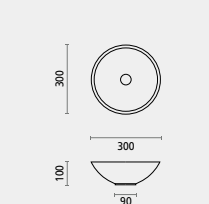

**PIEMONTE**  
54



REF **6002**  
0268\_00

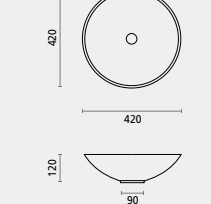

**SAJA**  
56



REF **6003**  
0339\_00

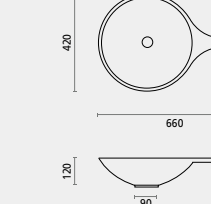

**NANSA**  
70



REF **6009 / 0302**  
01248\_00



**MONTY**  
72



REF **6004**  
0796\_00



**BARI**  
44



REF **6022**  
01295\_00



**LUENA**  
63



REF **6005**  
0509\_00



**LUENA**  
63



REF **6006**  
0618\_00



**LUENA**  
60



REF **6007**  
0939\_00

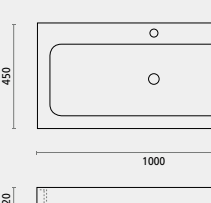

VENETO  
76



REF 6014  
0967\_00

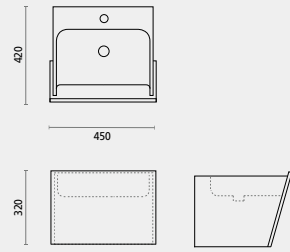

VENETO  
78



REF 6010  
01639\_00

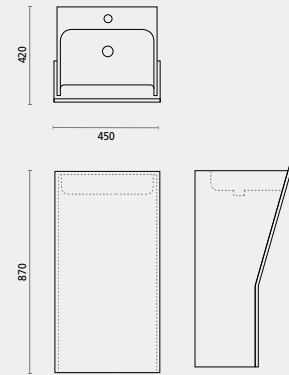

BARROS  
82



REF 6013  
01785\_00

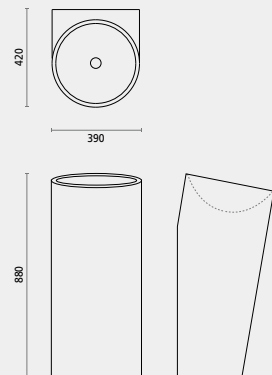

CALABRIA  
64



REF 6011A  
0998\_00

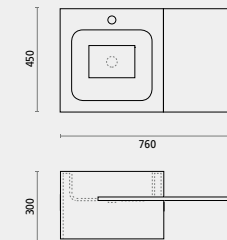

CALABRIA  
64



REF 6011B  
0998\_00

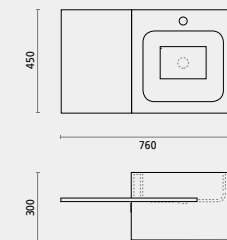

CALABRIA  
66



REF 6012  
01967\_00

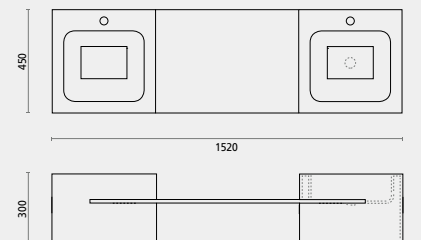

LAVABO CUADRADO  
48



REF 6025  
01795\_85



MÓDULO CUADRADO  
48



REF 6026  
01989\_85

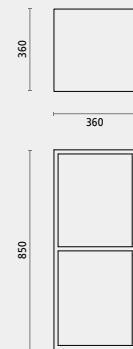

BELTED  
40

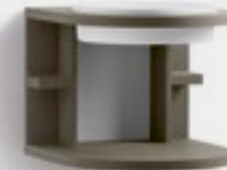

REF 6023GR / 6023RB  
01795\_85

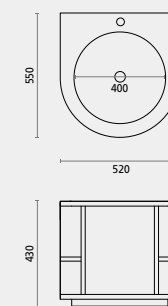

BELTED  
40



REF 6024GR / 6024RB  
02895\_00

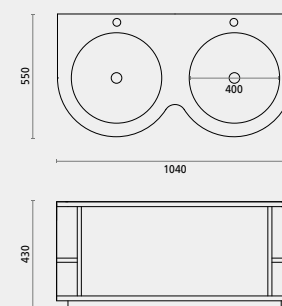

PADUA  
28



REF 6027  
01575\_00

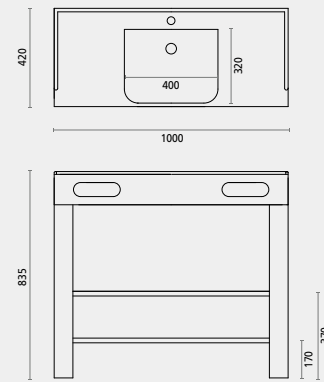

LIVORNO  
30



REF 6028  
01795\_00

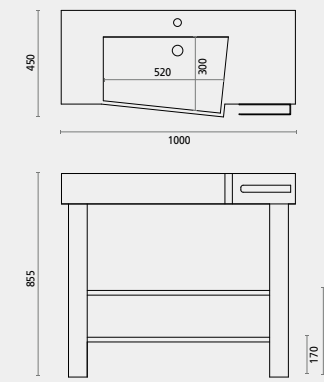

SORRENTO  
32



REF 6029  
01195\_00

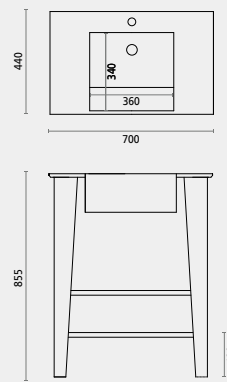

SORRENTO B  
32



REF 6030  
01489\_00

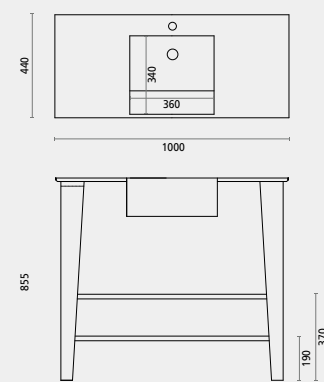

TARENTO  
36



REF 6031  
01495\_00

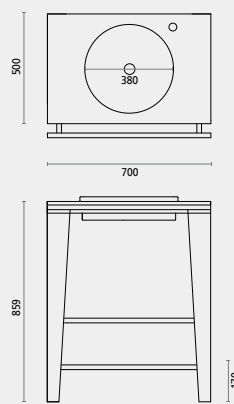

TARENTO B  
36



REF 6032  
01895\_00

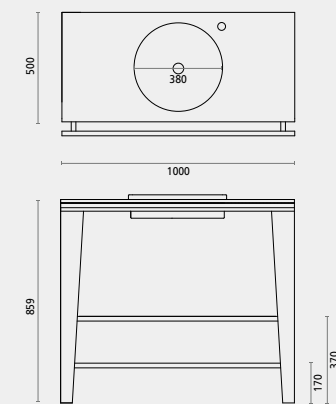

**SEYCHELLES**  
100



REF 00379 Beige / 00380 Black  
0795\_00

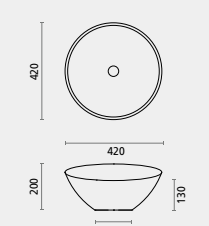

**ZANZIBAR**  
112



REF 00381 Beige / 00382 Black  
0595\_00

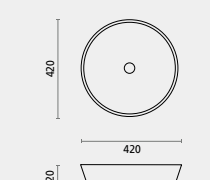

**MADAGASCAR**  
92



REF 00383 Beige / 00384 Black  
0695\_00

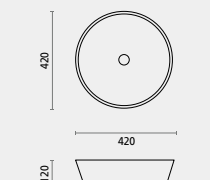

**REUNION**  
104



REF 00387 Beige / 00388 Black  
0695\_00

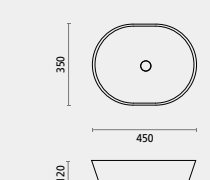

**REUNION**  
104



REF 00389 Beige / 00390 Black  
0895\_00

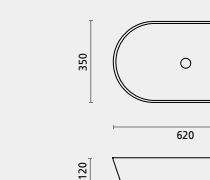

**MAURITIUS**  
96



REF 00385 Beige / 00386 Black  
0965\_00

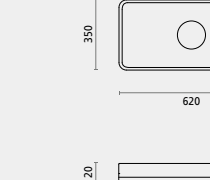

**MIRAGE**  
140



REF 00373 Beige / 00374 Black  
0582\_95

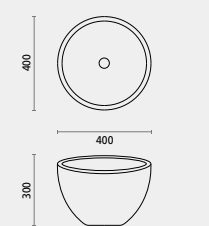

**FIJI**  
162



REF 00316 Beige / 00315 Black  
0565\_95



**ICONO**  
130



REF 00338 Beige / 00339 Black  
0585\_85

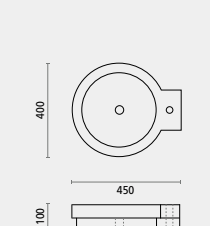

**VERSALLES**  
134



REF 00354 Beige / 00355 Black  
0619\_00

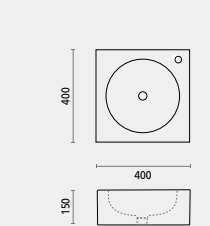

**MONTENEGRO**  
154



REF 00367 Beige / 00368 Black  
0598\_00

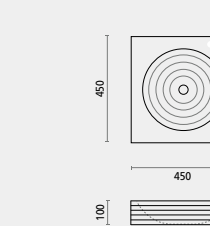

**DUOTONO A**  
144



REF 00361 Beige / 00362 Black  
0489\_00



**DUOTONO B**  
148



REF 00365 Beige / 00366 Black  
0489\_00



**COPLATO**  
150



REF 00363 Beige / 00364 Black  
0519\_00

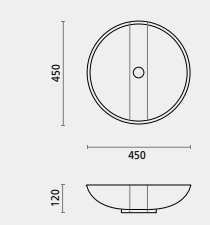

**VULKA**  
142



REF 00369 Beige / 00370 Black  
0867\_00

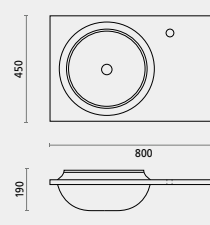

**AROS**  
156



REF 00371 Beige / 00372 Black  
01095\_00

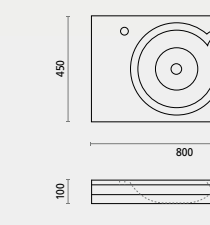

COMOROS  
108



REF 00391 Beige / 00392 Black  
02395\_00

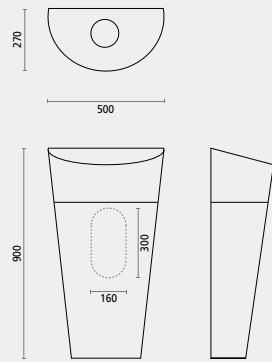

LUNGO SQUARE  
158



REF 00358 Beige / 00359 Black  
01895\_95

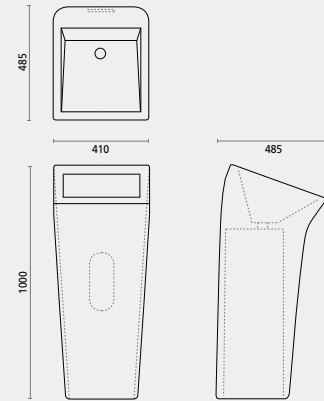

VERONA  
126



REF 00348 Beige  
02439\_00

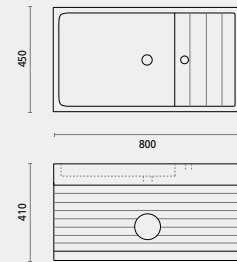

CALABRIA  
138



REF 00346 Beige / 00347 Black  
03985\_00

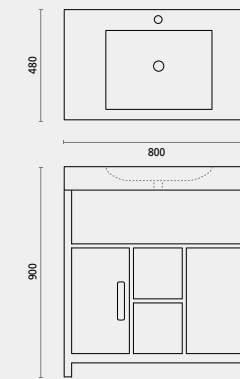

PEDESTAL  
130



REF 00331  
0414\_85



VERSALLES  
134



REF 00356  
01119\_00

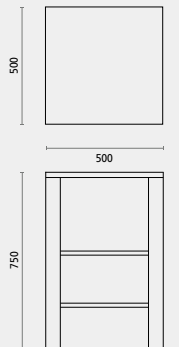

OCO  
122



REF 00342 Beige / 00343 Black  
02695\_00

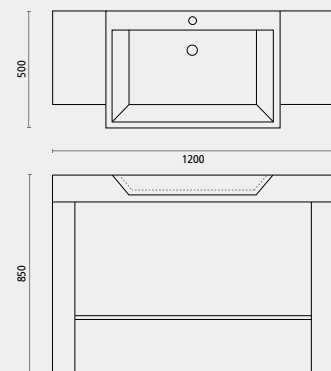

SIMI  
116



REF 00332 Beige / 00333 Black  
03985\_00

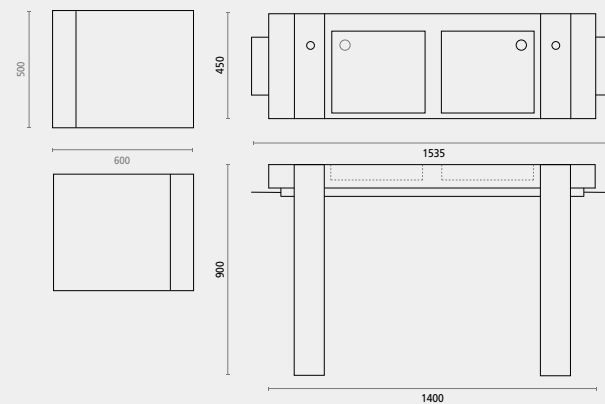

SIMI  
116



REF 00336 Beige / 00337 Black  
013985\_00

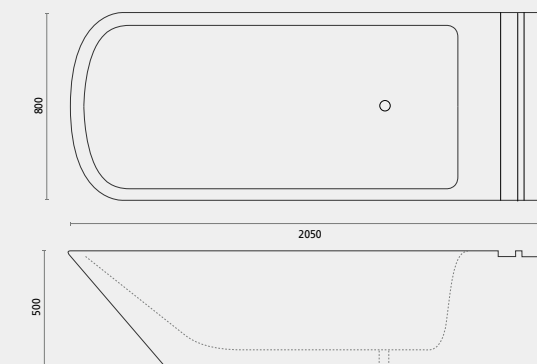



SIMI  
116



REF 00334 Beige / 00335 Black  
02195\_00

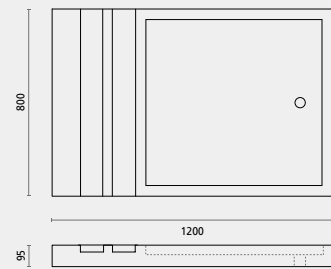

VERONA  
126



REF 00350 Beige  
01695\_00

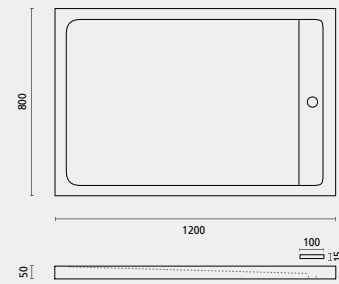

VERSALLES  
134



REF 00352 Beige / 00353 Black  
01309\_00

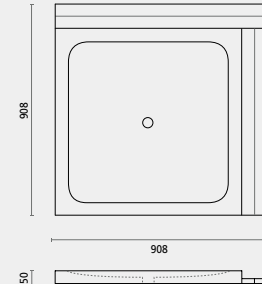

ICONO  
130



REF 00340 Beige  
02439\_00

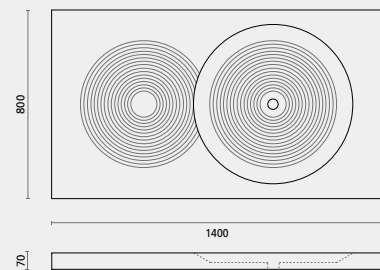

OCO  
122



REF 00344 Beige / 00345 Black  
02439\_00

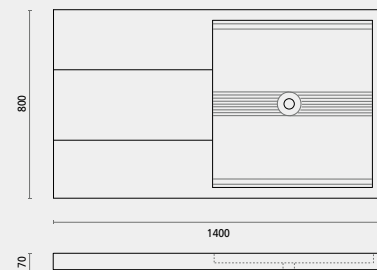

**REINOSA**  
168



REF 08038 Cement  
0389\_00



**AMPUERO**  
172



REF 08004 Cement  
0349\_00

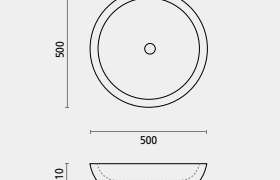

**NOVALES**  
174



REF 08008 Cement / 08007 Terrazzo  
0349\_00



**SARÓN**  
194



REF 08010 Cement / 08009 Terrazzo  
0248\_00



**SOBARZO**  
206



REF 08020 Cement  
0379\_00

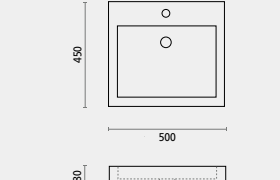

**PARBAYON**  
200



REF 08016 Cement / 08015 Terrazzo  
0429\_00



**CIEZA**  
178



REF 08012 Cement / 08011 Terrazzo  
0459\_00

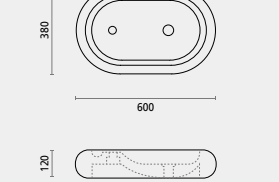

**BARROS**  
182



REF 08014 Cement  
0439\_00

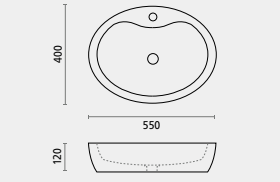

**CACICEDO**  
184



REF 08006 Cement  
0349\_00

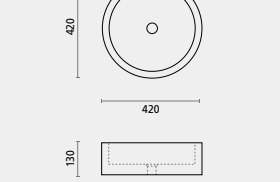

**CAMARGO**  
198



REF 08032 Cement / 08031 Terrazzo  
0589\_00



**PREZANES**  
204



REF 08023 Terrazzo  
0679\_00



**BERANGA**  
202



REF 08018 Cement / 08017 Terrazzo  
0598\_00



**SUANCES**  
186



REF 08034 Cement / 08033 Terrazzo  
0419\_00



**BOLEAN**  
190



REF 08002 Cement / 08001 Terrazzo  
0396\_00

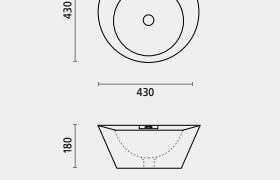

**POLANCO**  
192



REF 08022 Cement / 08021 Terrazzo  
0248\_00



**POTES**  
208



REF 08026 Cement / 08025 Terrazzo  
0529\_00



**POTES**  
208



REF 08028 Cement / 08027 Terrazzo  
0638\_00

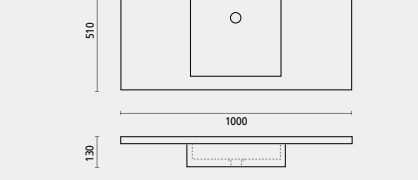

**POTES**  
208



REF 08030 Cement / 08029 Terrazzo  
0986\_00



**BERNA**  
220



REF 5001  
01596\_00

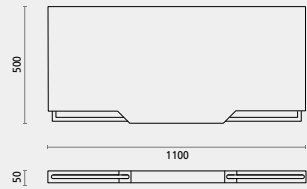

**BERNA**  
216



REF 5002  
02389\_00

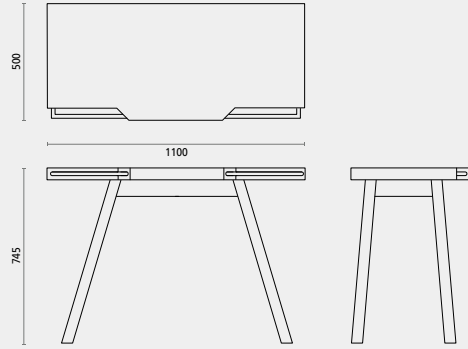

**SALZBURGO**  
222



REF 5003  
02598\_00

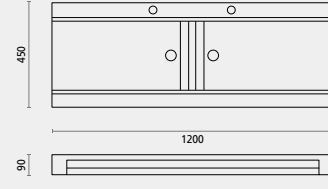

**RIBE**  
228



REF 5004  
01976\_00

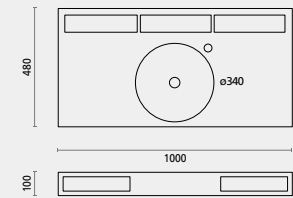

**BERGEN**  
226

REF 5005  
01289\_00

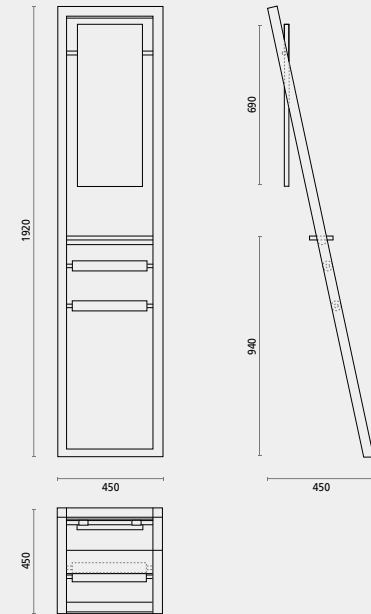

SICILIA  
236



REF 1501MC  
0695\_00

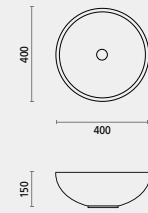

SICILIA  
236



REF 1502MC  
0695\_00

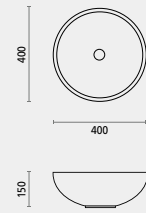

SICILIA  
240



REF 1503MC  
0695\_00

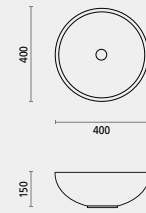

SICILIA  
240



REF 1504 MC  
0795\_00

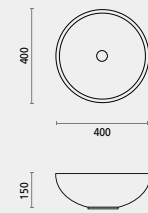

**BATH COLLECTION S.L.**

Bajada del Caleruco 21 A  
39012 Santander (Spain)

Tel. +34 942 32 12 22  
Fax. +34 942 32 48 98

thebathcollection@thebathcollection.com  
www.thebathcollection.com

Concept, Photography, Styling  
and Graphic Design:  
www.mito.eus

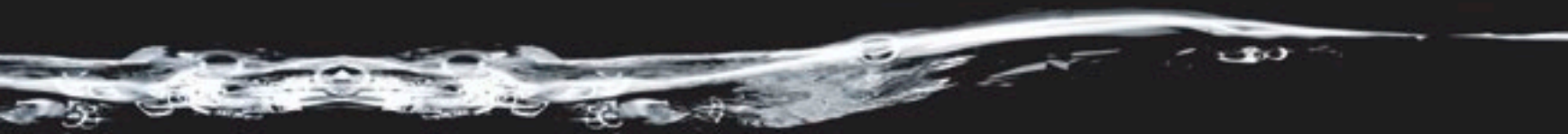

[www.thebathcollection.com](http://www.thebathcollection.com)

bathco